

Zintra Baffles 48" Square Installation Instructions

FINISHED ASSEMBLY

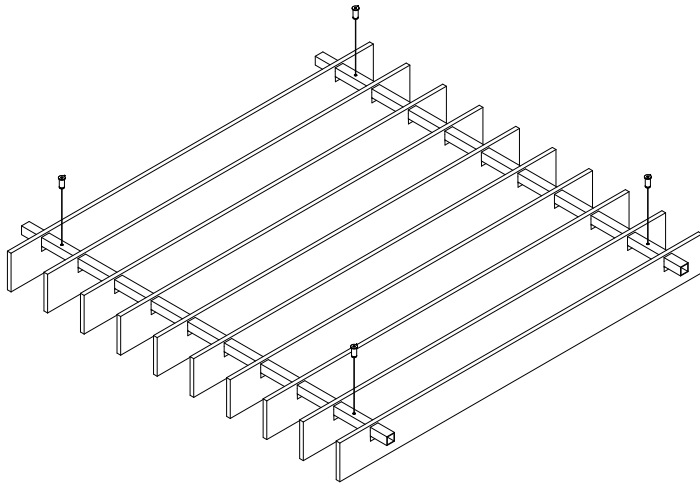

PARTS LIST

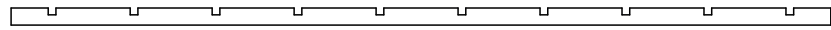

SQUARE MOUNTING BEAM

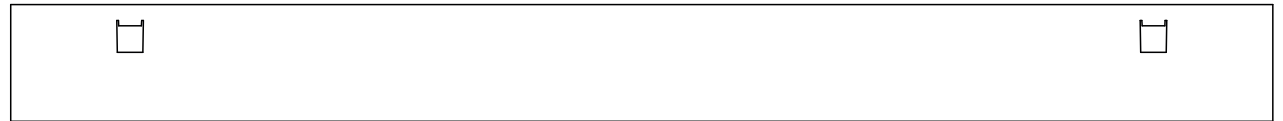

BAFFLES



**ADJUSTABLE
FASTENER**

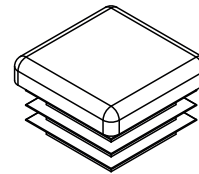

END CAPS

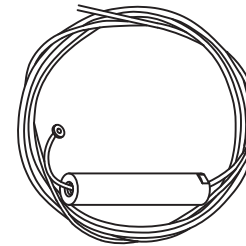

CABLE

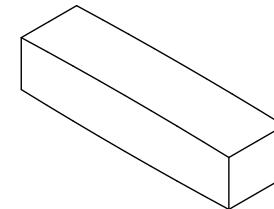

CONNECTORS

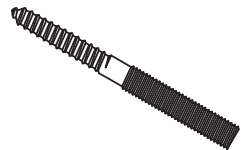

**HANGER
BOLTS**

Zintra Baffles 48" Square Installation Instructions

STEP 1

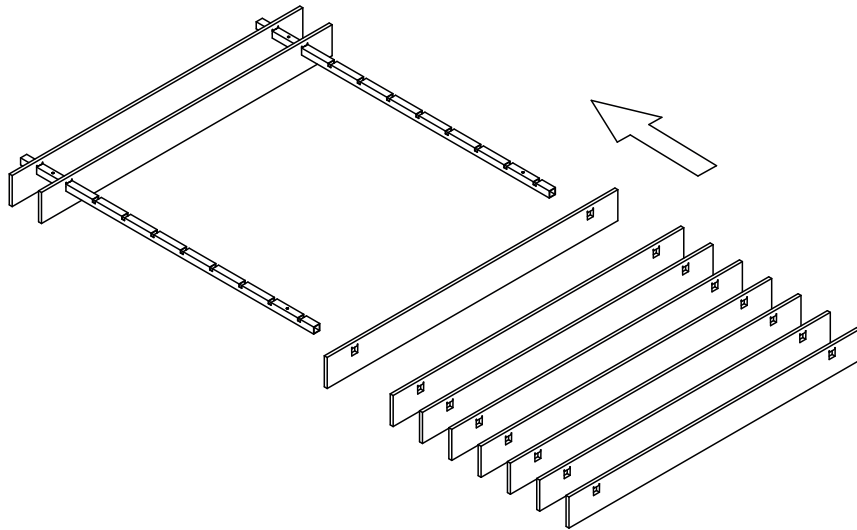

Thread baffles onto the square mounting beams provided.

STEP 2

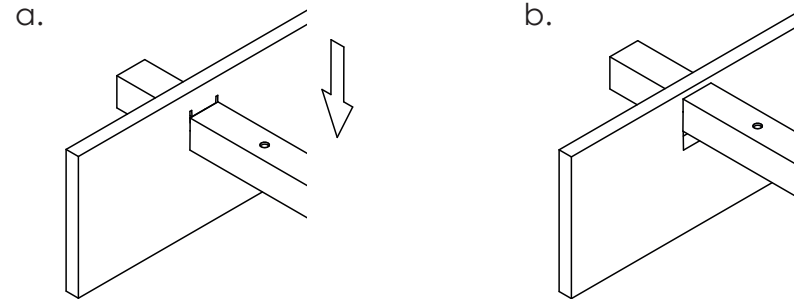

Lock each baffle into position by pushing downwards as shown.

STEP 3

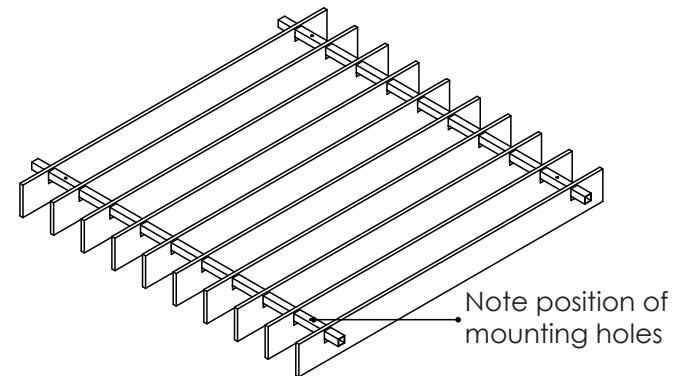

Baffle assembly is complete

Zintra Baffles 48" Square Installation Instructions

STEP 4

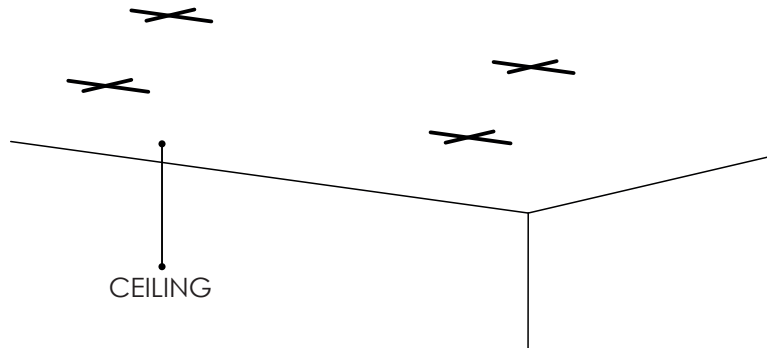

Determine the suspension points for the Baffle System that best suit the site specific installation. It is recommended to have three suspension points for each crossrunner, each end and a mid point.

Once the suspension points on the Box Baffle have been selected, identify the corresponding points on the ceiling.

STEP 5

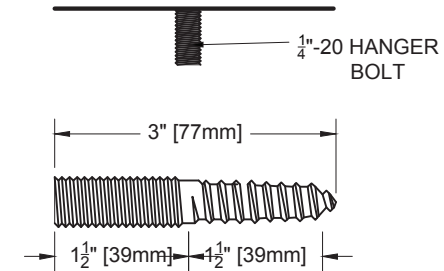

Install the 1/4 - 20 hanger bolts to the substrate. The supplied hanger bolts are intended for use in wood only. For other substrates the installer will need to source the appropriate hardware.

STEP 6

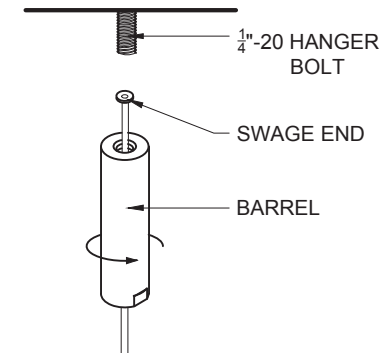

Identify the threaded end of the barrel and the swage end of the cable. Insert the plain end of the supplied wire through the large threaded end of the barrel until it is fully seated in the barrel. Attach the threaded end of the barrel to the 1/4 - 20 hanger bolt.

Zintra Baffles 48" Square Installation Instructions

STEP 7

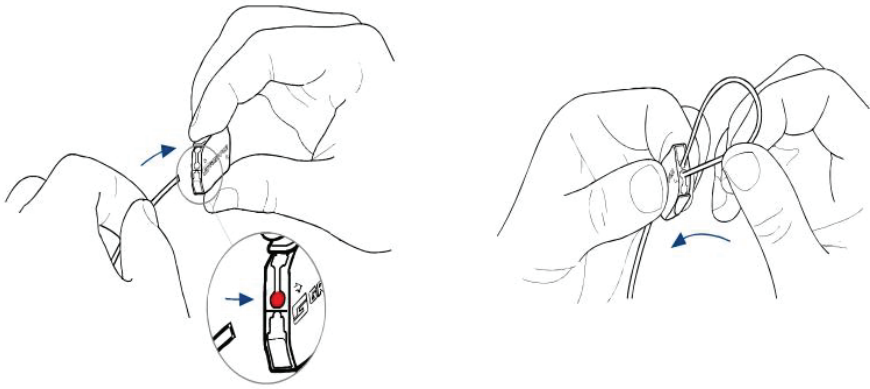

Insert the plain end of the cable through one side of the adjustable fastener. Loop the wire around the crossrunner at the predetermined locations. Re-insert the plain end of the cable through the remaining side of the adjustable fastener.

STEP 8

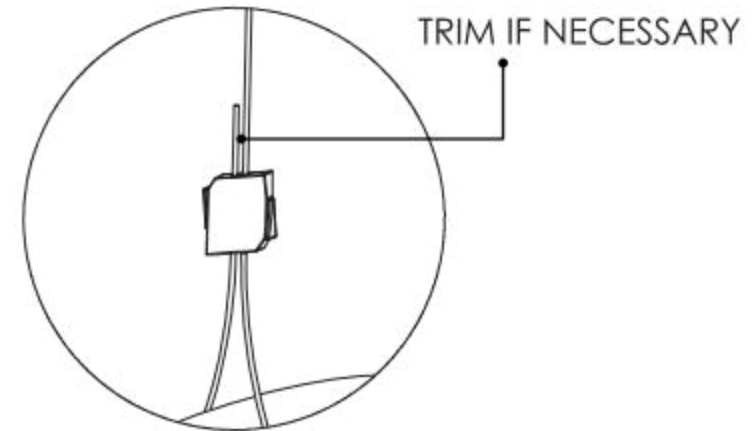

Once the Box Baffle System is properly suspended, trim the excess cable. The cable is adjustable by depressing tab on appropriate side.

Zintra Baffles 48" Square Installation Instructions



SIDE VIEW

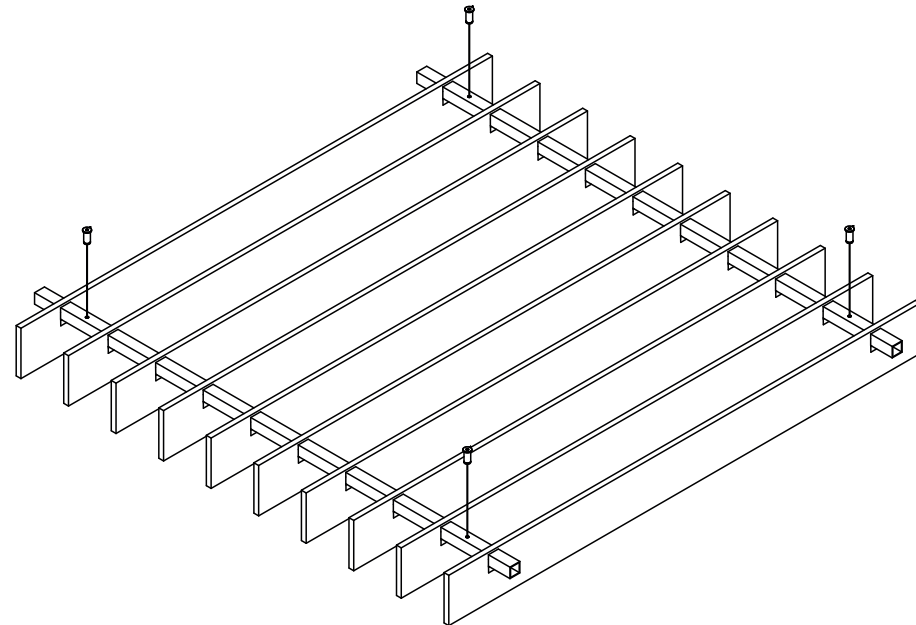

COMPLETED INSTALL

Zintra Baffles 48" Square Installation Instructions

CONNECTOR DETAIL

To connect multiple baffle assemblies together, insert connectors into open ends of square mounting beams and push assemblies together as shown.

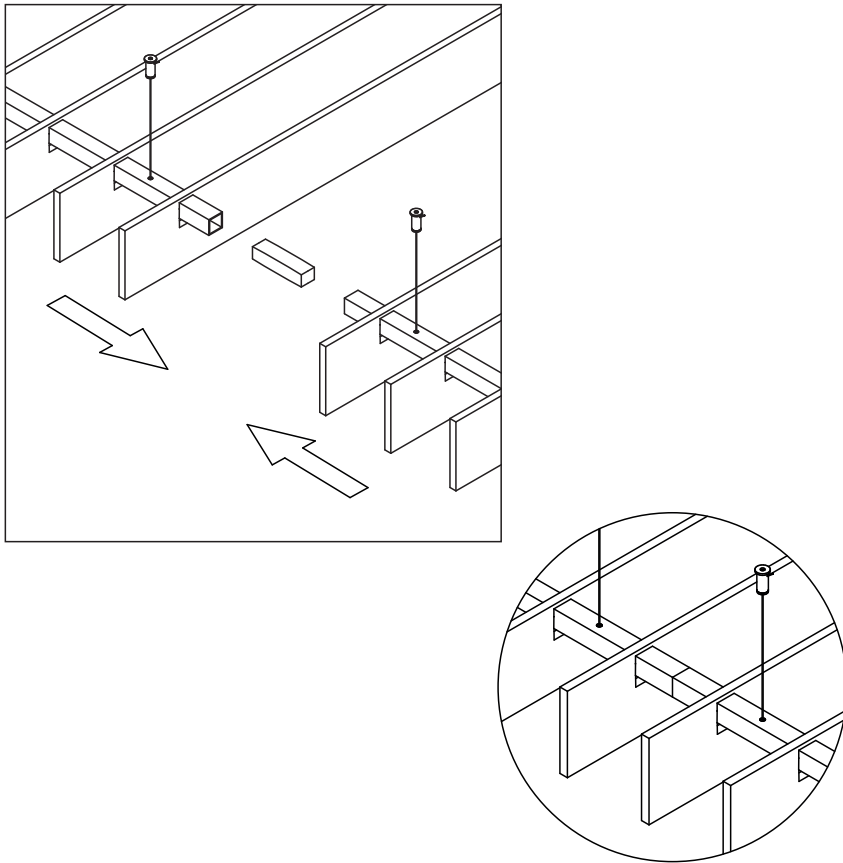

CAPPING DETAIL

To cap ends of baffle assembly- insert end caps provided as shown.

