

Zintra Box Tiles
Installation Instructions
HEXAGON, DIAMOND, PITCHED, SQUARE

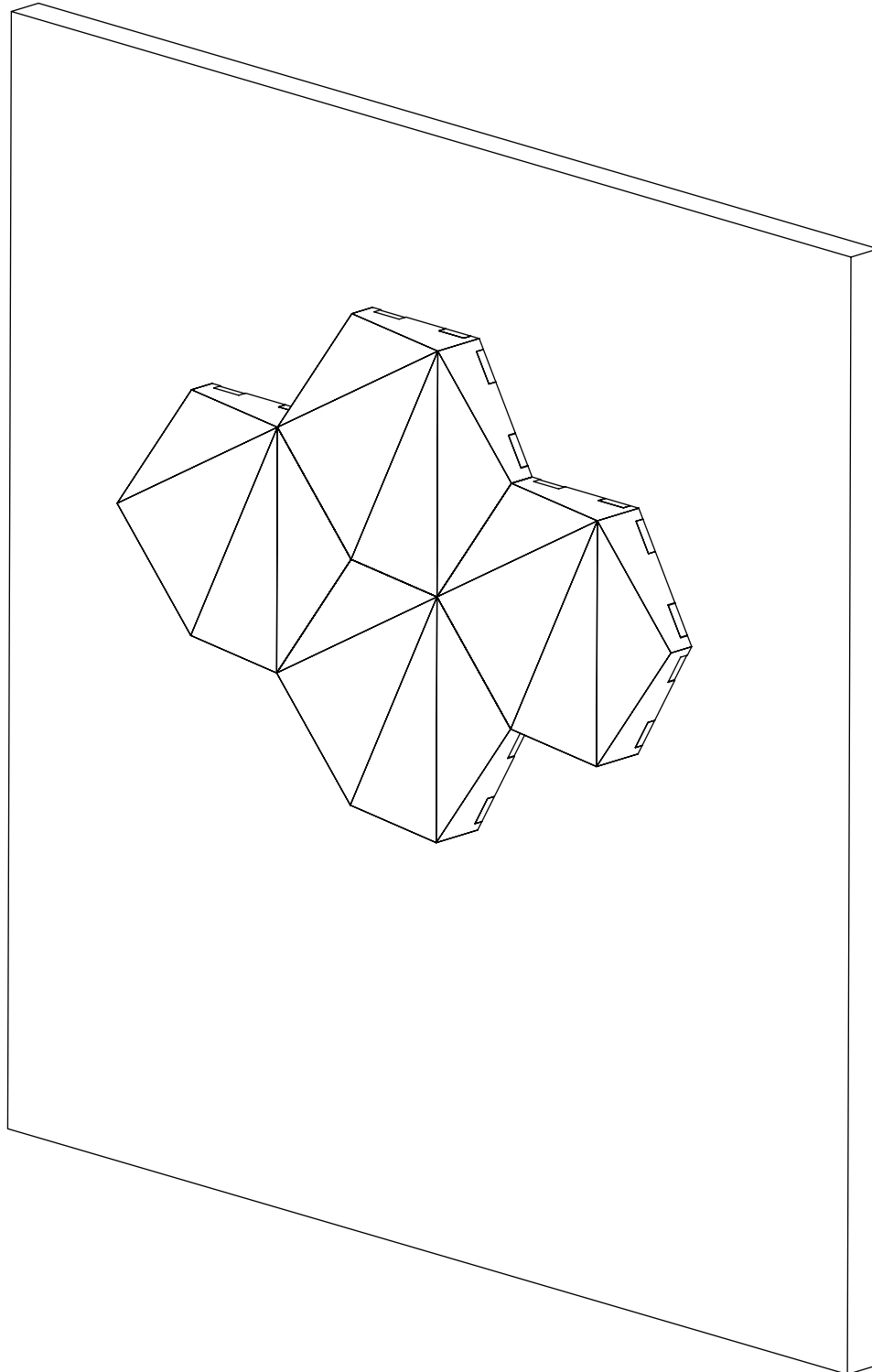

Zintra Box Tiles Installation Instructions

HEXAGON, DIAMOND, PITCHED, SQUARE

PARTS AND HARDWARE

ZINTRA BOX TILE - FLAT PACKED SHAPE

TYPICAL DESIGN SHOWN - REFER BELOW

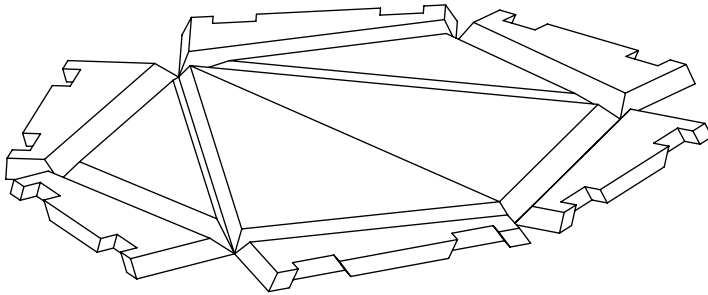

ZINTRA BOX TILE - JOINERS

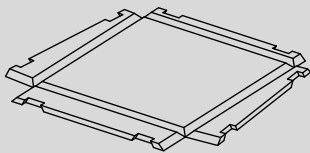
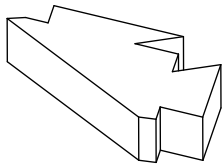

PITCHED - FLAT PATTERN

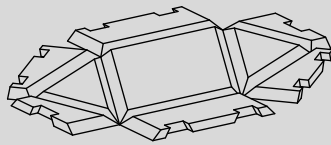

DIAMOND - FLAT PATTERN

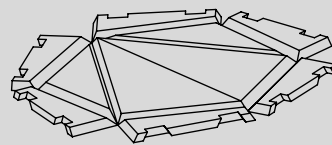

HEXAGON - FLAT PATTERN

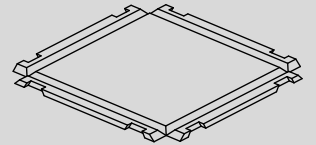

SQUARE - FLAT PATTERN

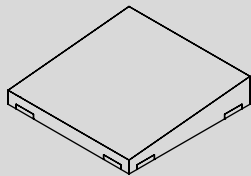

(1) PITCHED = (4) JOINERS

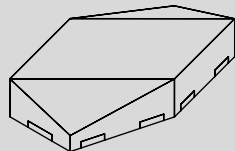

(1) DIAMOND = (4) JOINERS

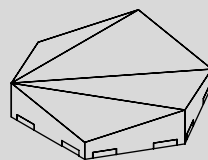

(1) HEXAGON = (6) JOINERS

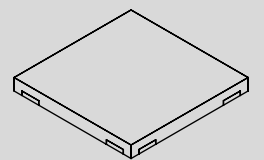

(1) SQUARE = (4) JOINERS

Zintra Box Tiles

Installation Instructions

HEXAGON, DIAMOND, PITCHED, SQUARE

YOU WILL NEED

SPIRIT LEVEL

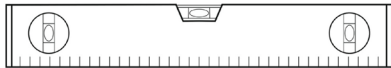

TAPE MEASURE

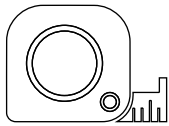

LOCTITE POWER GRAB EXPRESS HEAVY DUTY CONSTRUCTION ADHESIVE



APPROPRIATE APPLICATOR

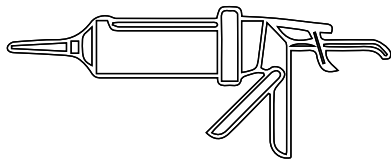

Zintra Box Tiles Installation Instructions

HEXAGON, DIAMOND, PITCHED, SQUARE

STEP 1

CHECK TO SEE IF PACKAGE CONTAINS ALL COMPONENTS. EVERY PACKAGE WILL COME WITH A NUMBER OF JOINERS PER FLAT PATTERN BOX TILE.

NUMBER OF JOINERS ARE AS FOLLOWS -

- (1) DIAMOND = (4) JOINERS
- (1) HEXAGON = (6) JOINERS
- (1) PITCHED = (4) JOINERS
- (1) SQUARE = (4) JOINERS

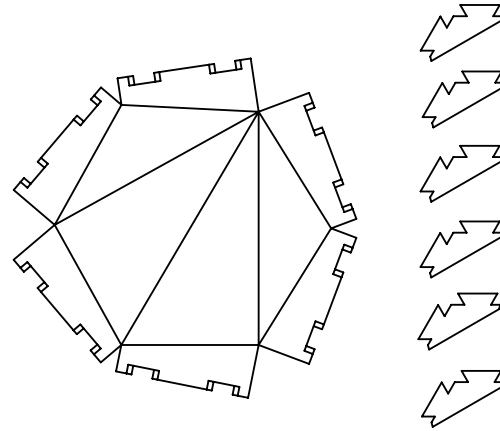

STEP 2

FOLD ZINTRA BOX TILE/TILES AS SHOWN IN (2).

ADD JOINERS TO THE BOX TILE TO KEEP IT FROM FOLDING INTO A FLAT SHAPE AS SHOWN IN (3).

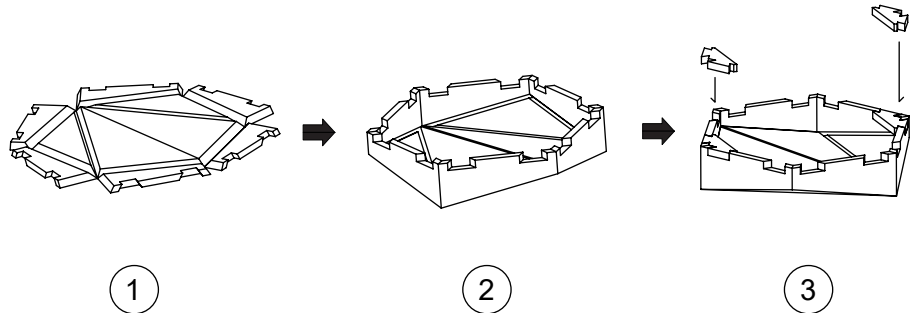

STEP 3

TRACE THE OUTLINE OF THE FIRST BOX TILE WITH A PENCIL TO MARK THE POSITION OF WHERE IT WILL BE FIXED TO THE SURFACE (SHOWN IN A).

MEASURE THE HEIGHT [X] AND WIDTH [Y] OF THE POSITION AND MAKE SURE THE PLACEMENT OF THE LINES ARE STRAIGHT USING A LASER LEVEL OR SPIRIT LEVEL.

NOTE: WHEN MARKING UP THE POSITION OF OTHER BOX TILES, MAKE SURE THE VERTEXES EDGES RUN FLUSH WITH THE ADJACENT BOX TILE (SHOWN IN B).

NOTE: DESIGN SHOWN = HEX

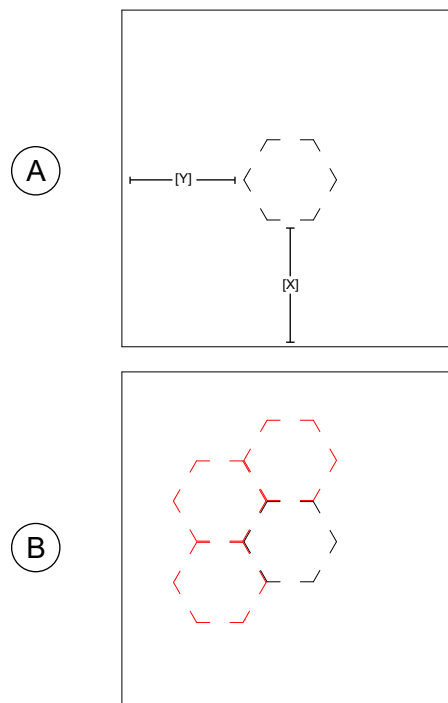

Zintra Box Tiles

Installation Instructions

HEXAGON, DIAMOND, PITCHED, SQUARE

STEP 4

APPLY CONSTRUCTION ADHESIVE TO THE BACK SIDE OF THE JOINERS SHOWN IN RED

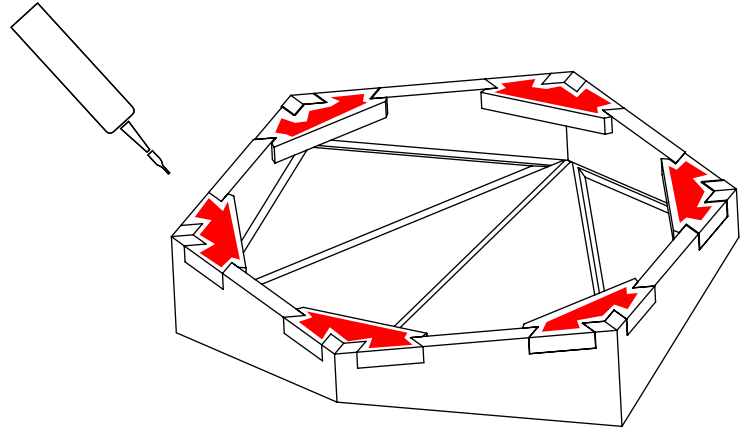

STEP 5

STICK BOX TILES TO THE MARKED POSITIONS FROM STEP 3.

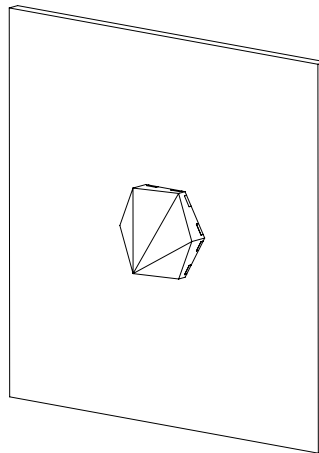

A

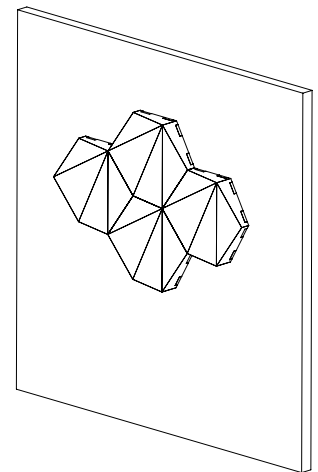

B

NOTE: DESIGN SHOWN = HEX