

Zintra Cloud Drante Installation Instructions

FINISHED ASSEMBLY

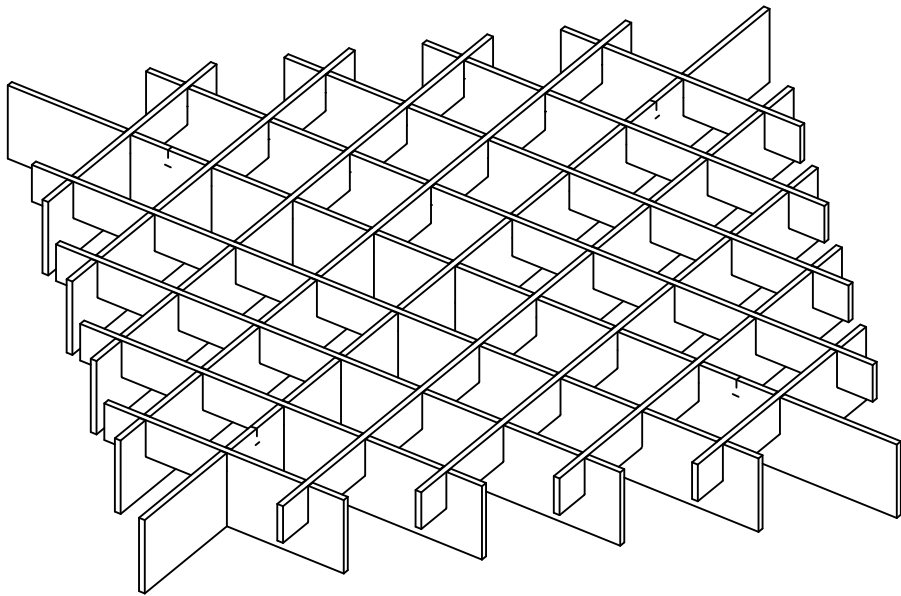

PARTS LIST



HANGER BOLTS

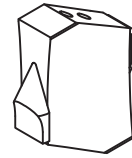

ADJUSTABLE FASTENER

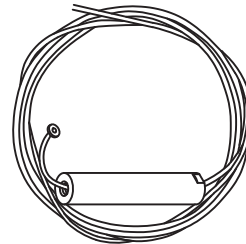

CABLE

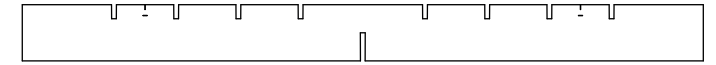

PROFILE 1A 1 OFF

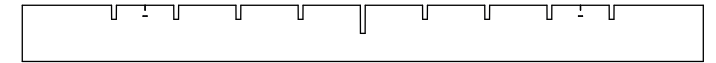

PROFILE 1B 1 OFF

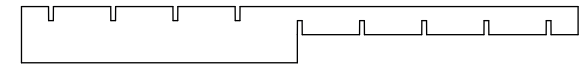

PROFILE 2 4 OFF

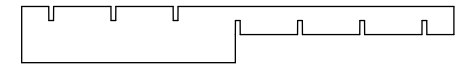

PROFILE 3 4 OFF



PROFILE 4 4 OFF

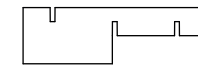

PROFILE 5 4 OFF

STEP 1

PARTIAL ASSEMBLY X

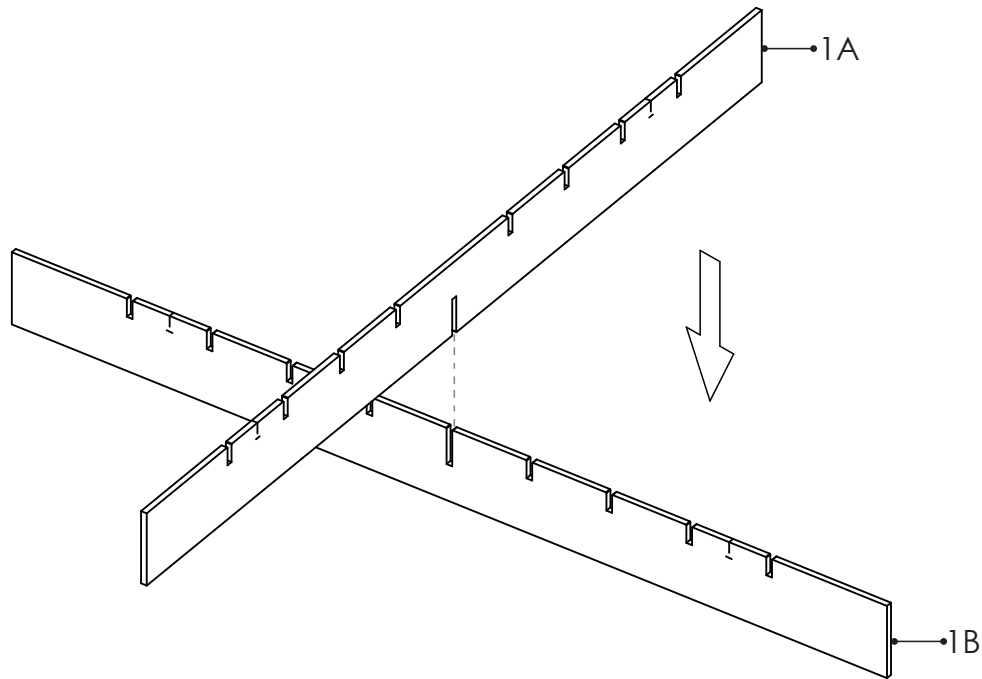

Assemble cloud profiles 1A & 1B as shown.
Note position of mounting slots.

STEP 2

PARTIAL ASSEMBLY X

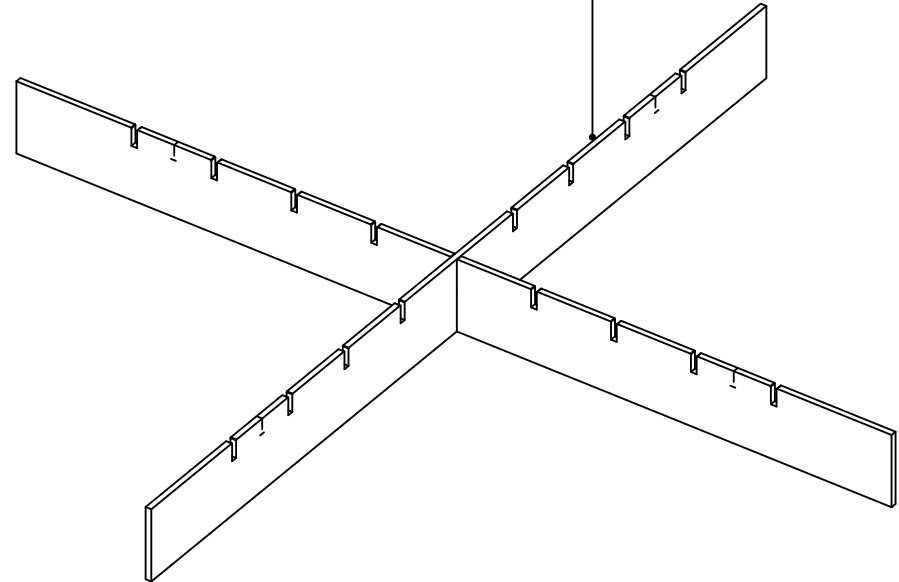

“Partial Assembly X” is complete. Put this aside for later.

Zintra Cloud Drante Installation Instructions

STEP 3

PARTIAL ASSEMBLY Y

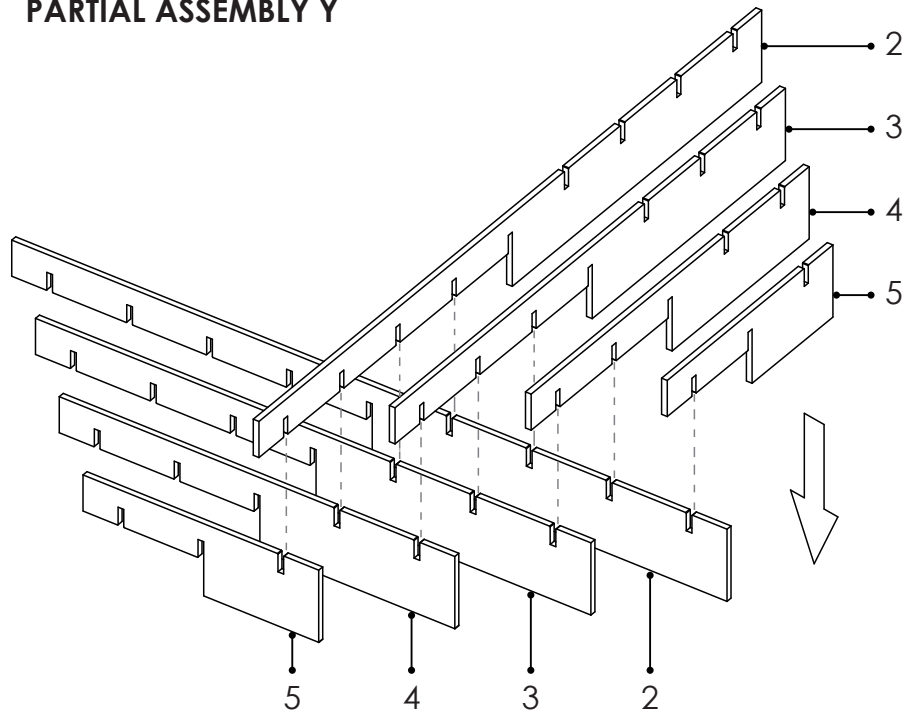

Assemble cloud profiles 5,4,3 & 2 as shown.

STEP 4

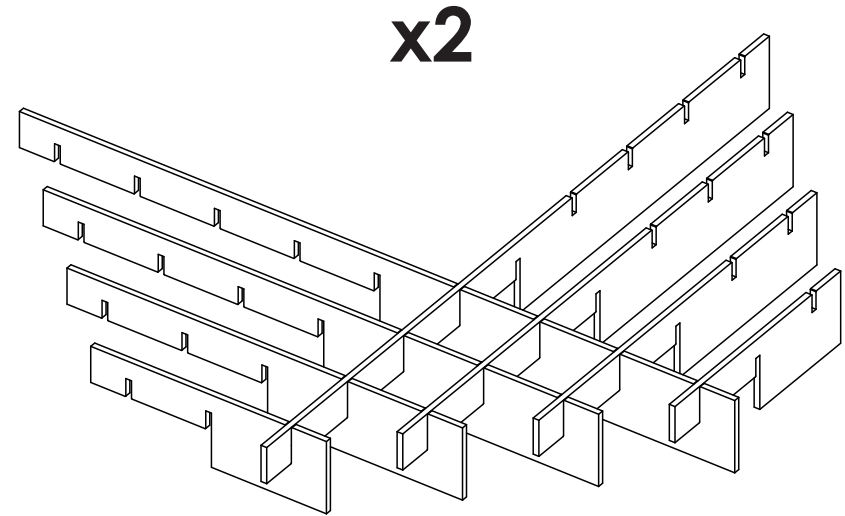

Create 2 of the above assemblies.

STEP 5

PARTIAL ASSEMBLY Y

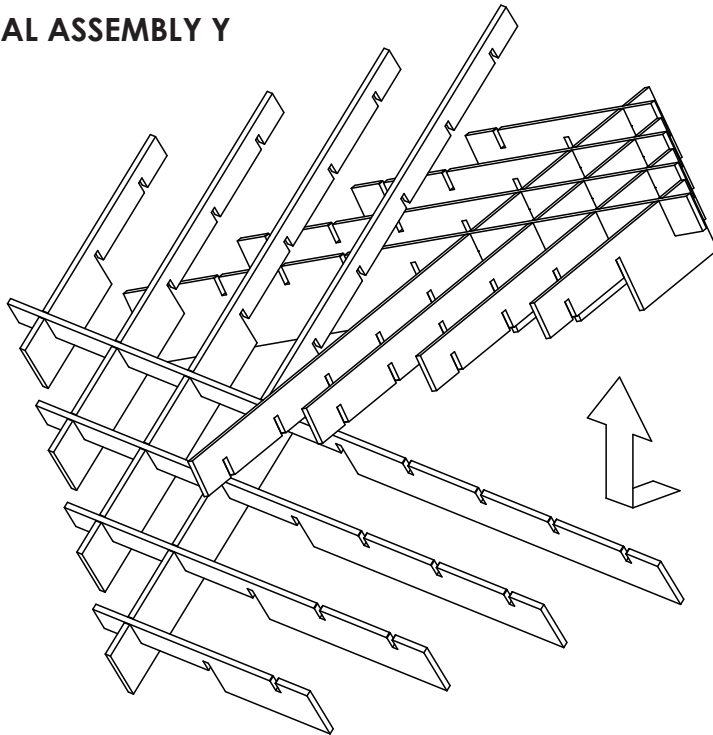

Interlock the two assemblies created in the previous step.

STEP 6

PARTIAL ASSEMBLY Y

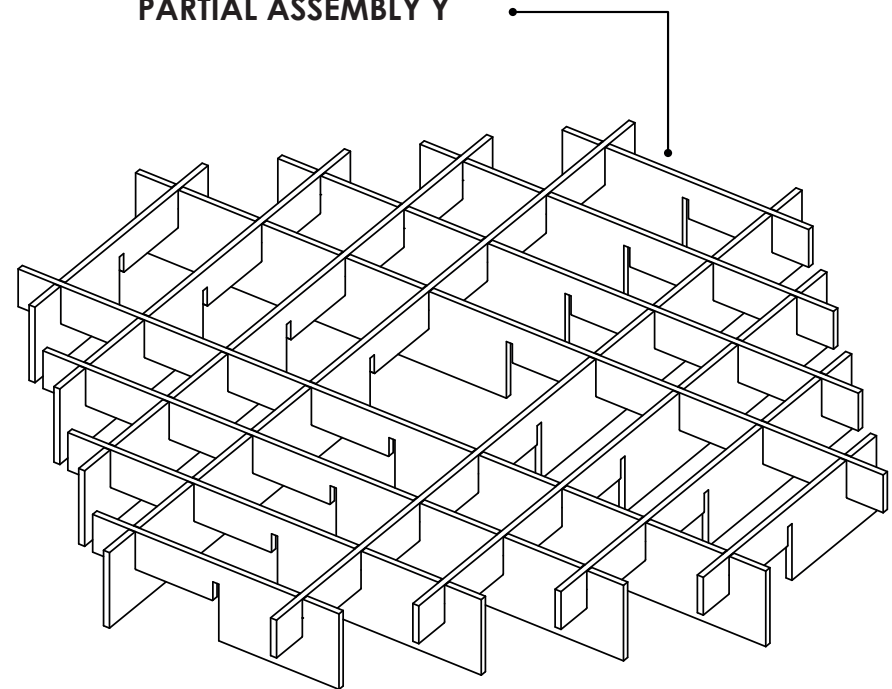

“Partial Assembly “Y” is complete. Put this aside for later.

STEP 7

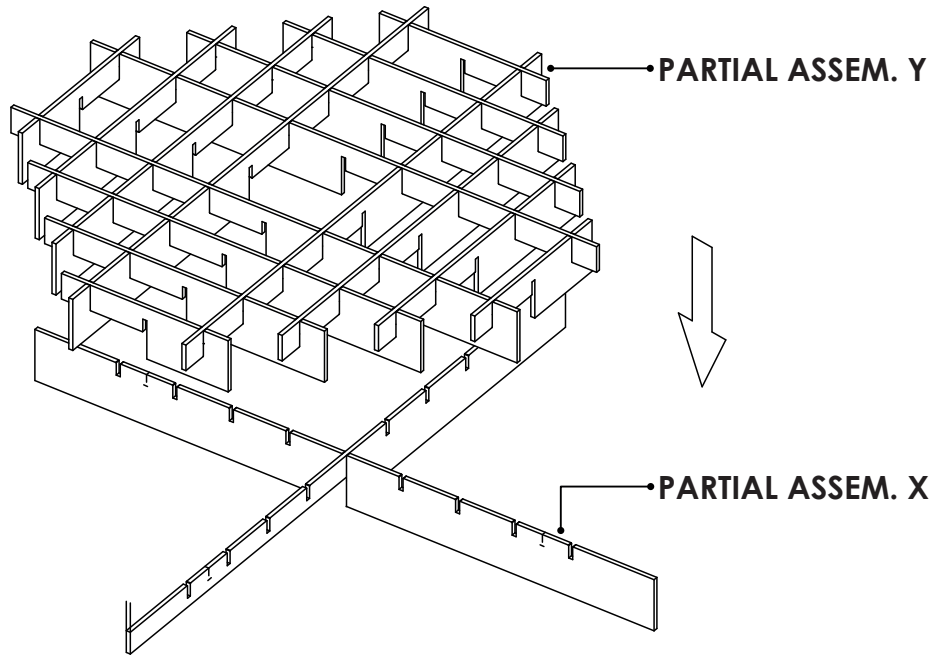

Join "Partial Assembly X" with "Partial Assembly Y" as shown.

STEP 8

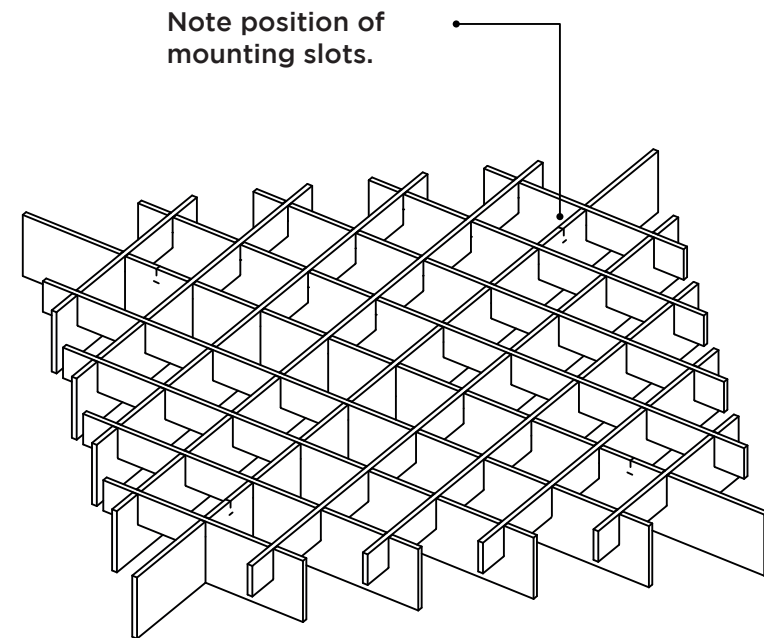

Assembly is complete.

Zintra Cloud Drante Installation Instructions

STEP 9

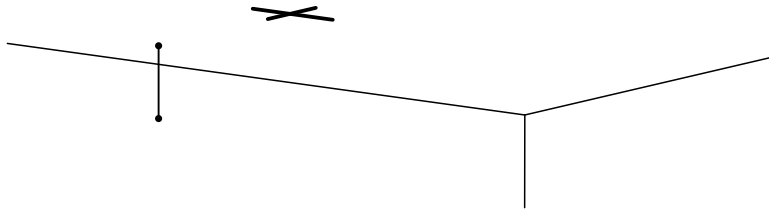

Place cloud assembly up to ceiling in desired location. Mark position of 2 x through holes which correspond to the center of each “set” of mounting slits on the mounting profile. Test that hole position is correct by temporarily suspending cloud on wires as shown in STEP 7 & 8.

STEP 10

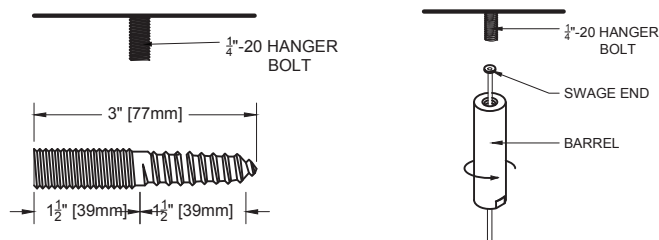

Install the 1/4”-20 hanger bolts to the substrate. The supplied hanger bolts are intended for use in wood only. For other substrates the installer will need to source the appropriate hardware.

STEP 11

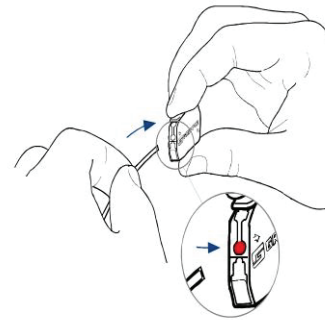

Feed swaged wire through tip of ‘wire adjuster’ (as shown). Push button (shown in grey) to adjust wire length. Release the button to lock in place.

STEP 12

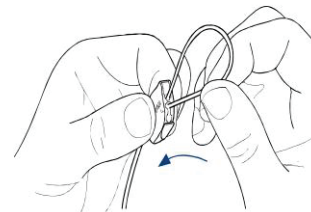

Insert the plain end of the cable through one side of the adjustable fastener. Loop the wire through the hole in the mounting profile and around the edge of the mounting profile at the predetermined locations. Re-insert the plain end of the cable through the remaining side of the adjustable fastener.

Zintra Cloud Drante

Installation Instructions

STEP 7

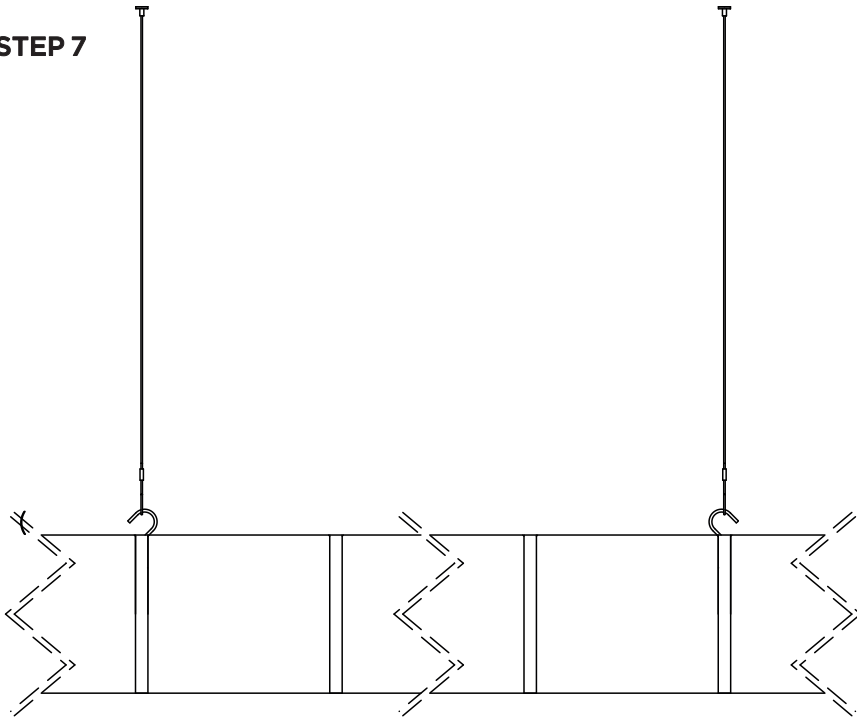

Re-adjust wire length as explained in STEP 5 until cloud hangs level.

STEP 8

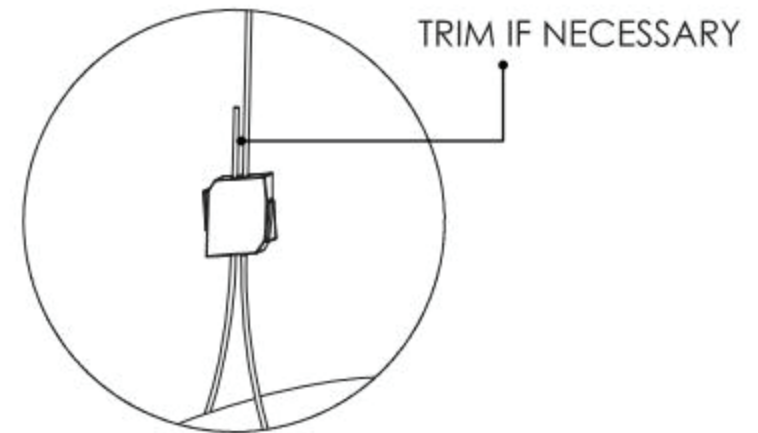

Once the Cloud is properly suspended, trim the excess cable. The cable is adjustable by depressing tab on appropriate side.