

Zintra Cloud Yoofoe Small Installation Instructions

FINISHED ASSEMBLY

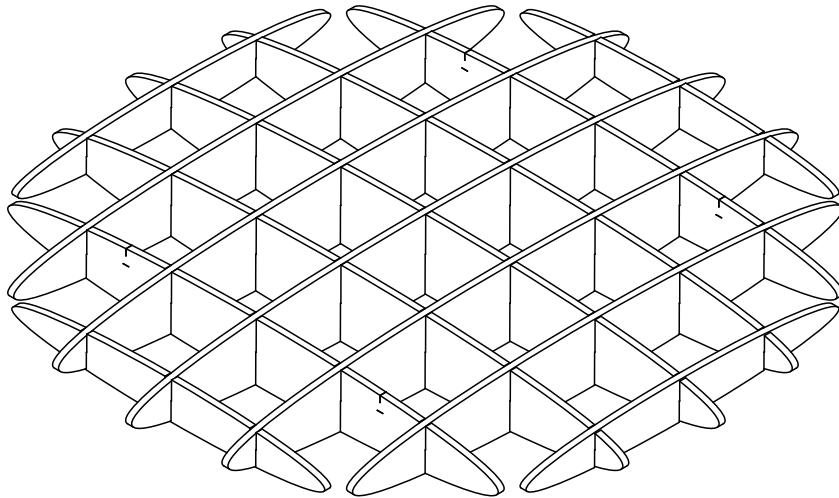

PARTS LIST



HANGER BOLTS

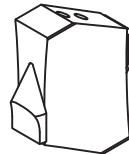

ADJUSTABLE FASTENER

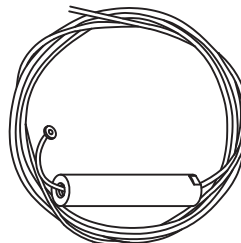

CABLE

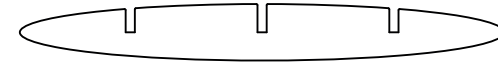

PROFILE 1
4 OFF

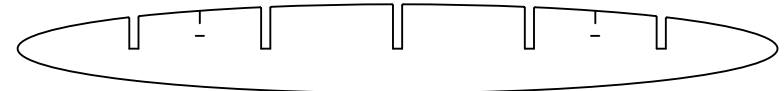

PROFILE 2A (MOUNTING PROFILE)
2 OFF

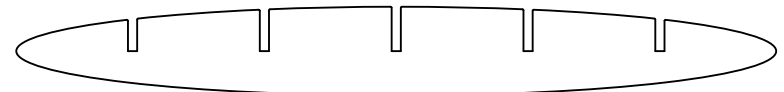

PROFILE 2B
2 OFF

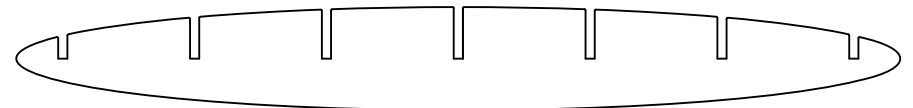

PROFILE 3
4 OFF

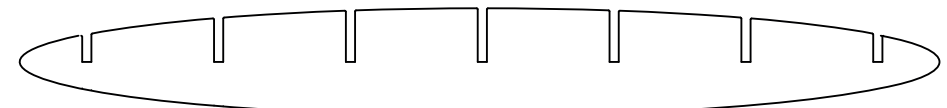

PROFILE 4
2 OFF

Zintra Cloud Yoofoe Small Installation Instructions

STEP 1

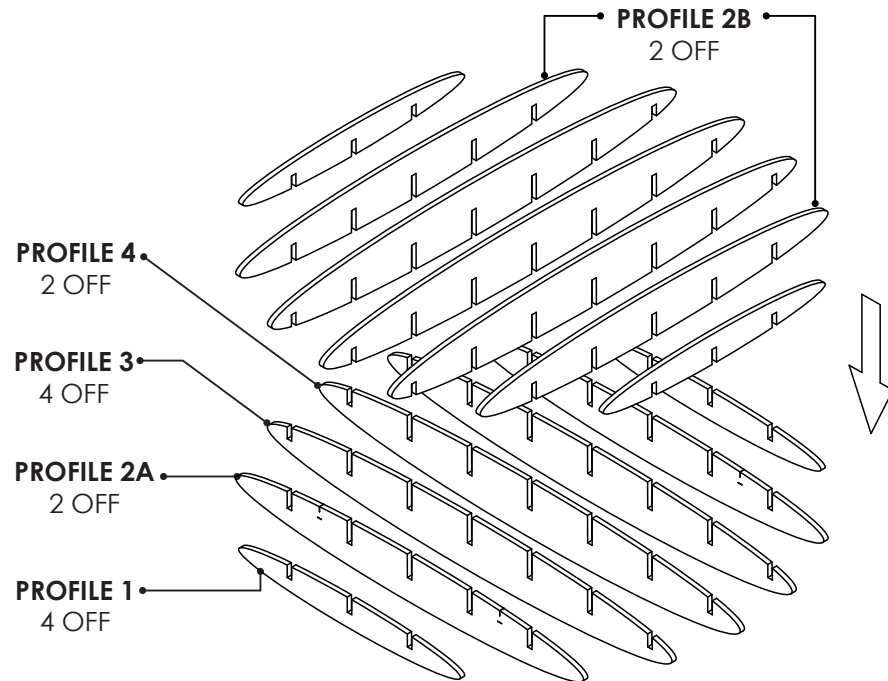

Assemble cloud profiles via slots.

STEP 2

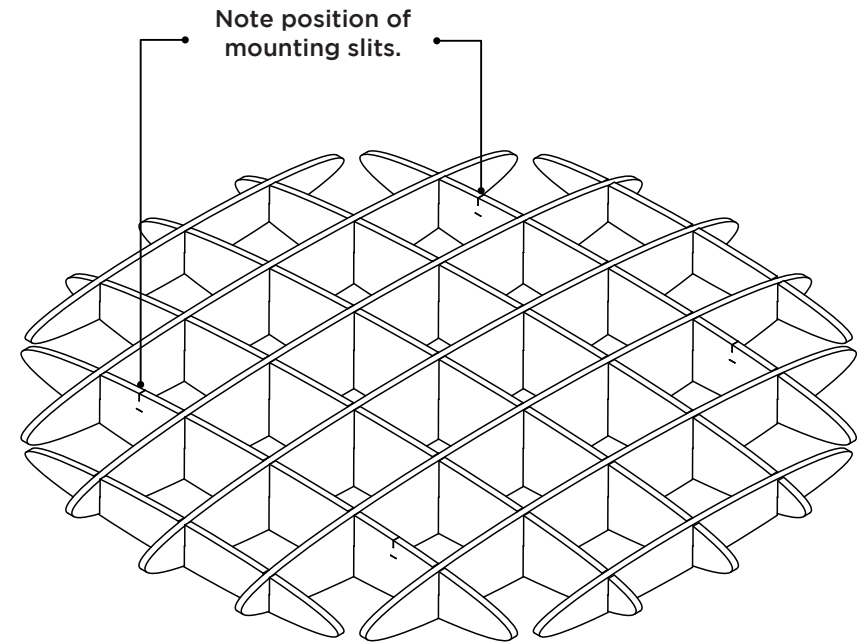

Zintra Cloud Yoofoe Small Installation Instructions

STEP 3

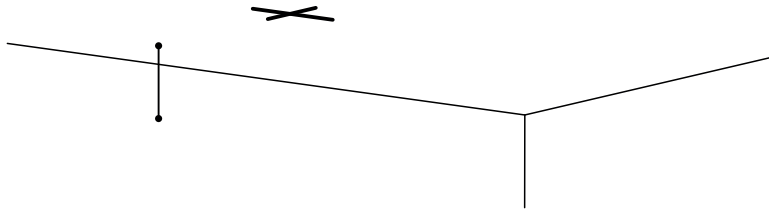

Place cloud assembly up to ceiling in desired location. Mark position of 2 x through holes which correspond to the center of each “set” of mounting slits on the mounting profile. Test that hole position is correct by temporarily suspending cloud on wires as shown in STEP 7 & 8.

STEP 4

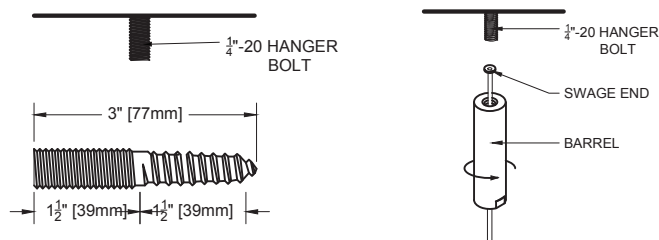

Install the 1/4”-20 hanger bolts to the substrate. The supplied hanger bolts are intended for use in wood only. For other substrates the installer will need to source the appropriate hardware.

STEP 5

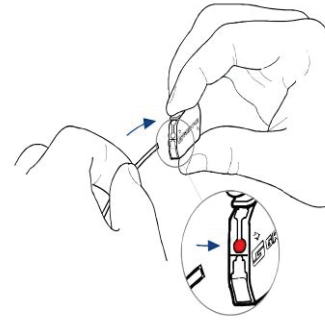

Feed swaged wire through tip of ‘wire adjuster’ (as shown). Push button (shown in grey) to adjust wire length. Release the button to lock in place.

STEP 6

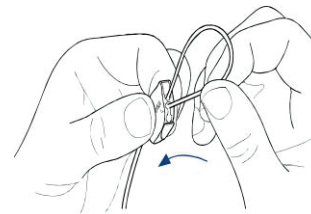

Insert the plain end of the cable through one side of the adjustable fastener. Loop the wire through the hole in the mounting profile and around the edge of the mounting profile at the predetermined locations. Re-insert the plain end of the cable through the remaining side of the adjustable fastener.

Zintra Cloud Yoofoe Small **Installation Instructions**

STEP 7

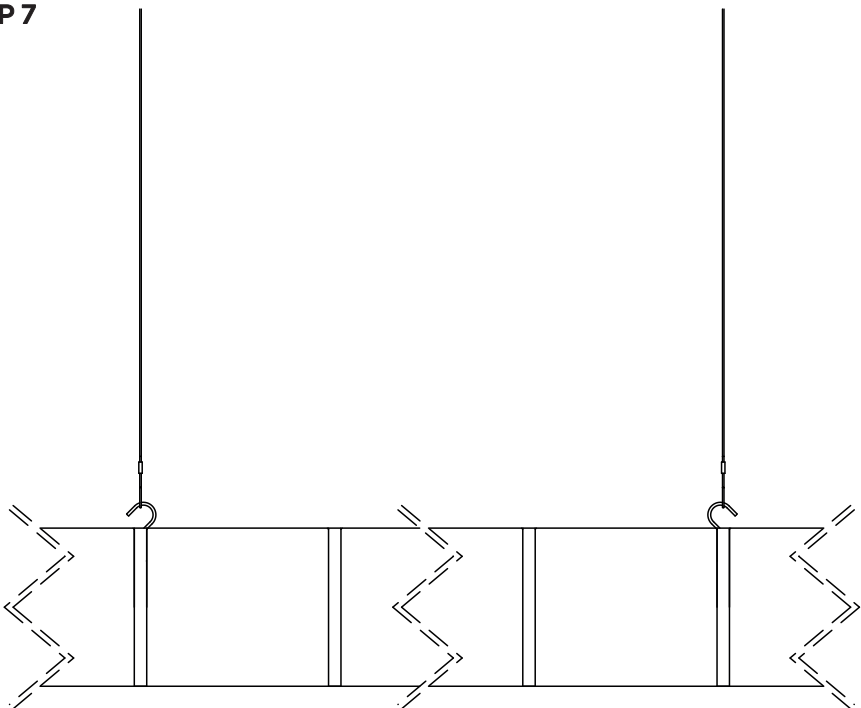

Re-adjust wire length as explained in STEP 5 until you are satisfied with the hanging height.

Note: There are two orientation options

*Please note, above linework is representative only. Your cloud may not be depicted.

STEP 8

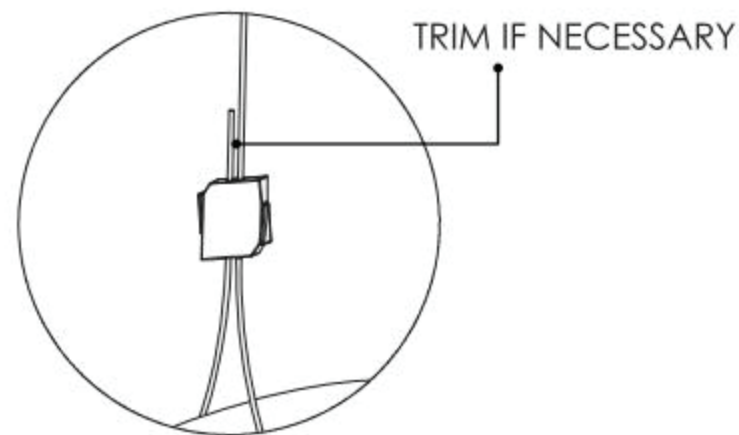

Once the Cloud is properly suspended, trim the excess cable. The cable is adjustable by depressing tab on appropriate side.