

Zintra Sticks Suspension Kit **Installation Instructions**

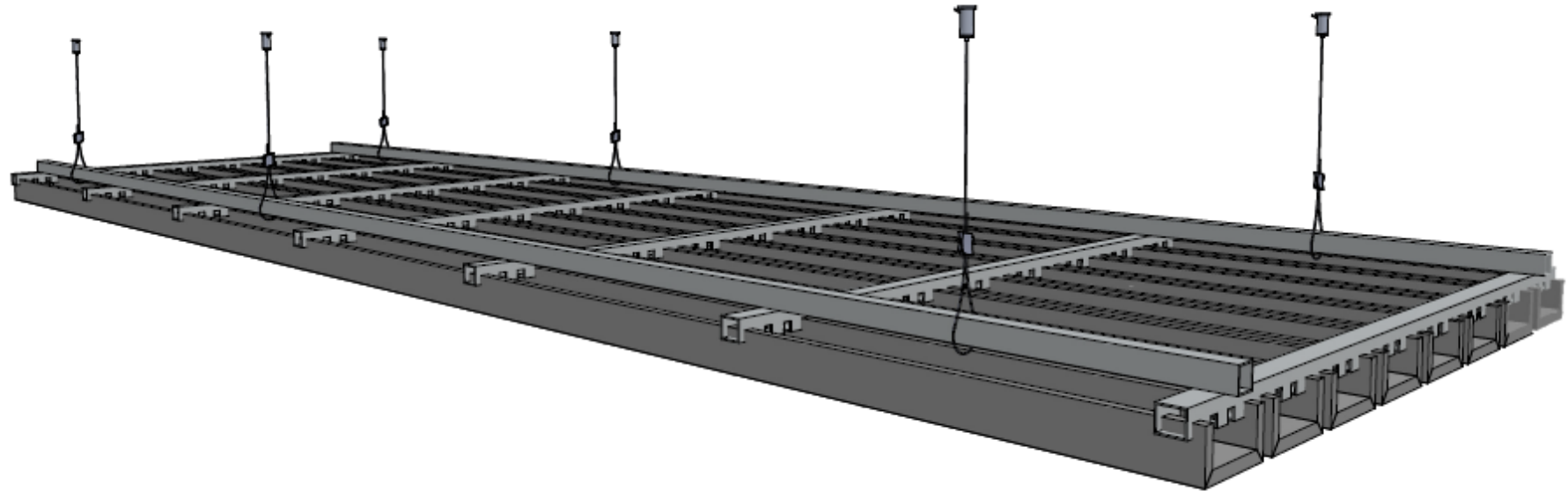

Zintra Sticks Suspension Kit Installation Instructions

PARTS AND HARDWARE

FOR A TYPICAL ASSEMBLY

ZINTRASTICKS - (8) WIDE OR (16) NARROW



(2) STANDARD ALUMINUM TUBE WITHOUT NOTCHES

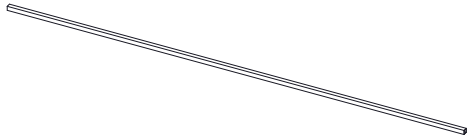

(7) STANDARD ALUMINUM TUBE WITH NOTCHES

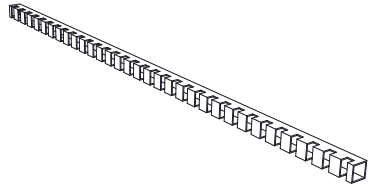

(6) 1/4" - 20 HANGER BOLT (FOR USE WITH WOOD SUBSTRATE ONLY)



(14) 90769A164 STEEL PHILLIPS ROUNDED HEAD DRILLING SCREW

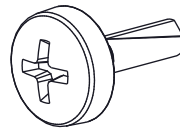

(6) ADJUSTABLE FASTENER



(6) CABLE WITH SWAGE END, AND BARREL

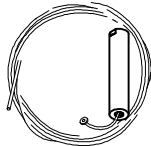

YOU WILL NEED

LEVEL

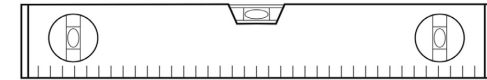

DROP SAW WITH
SUITABLE BLADE FOR
CUTTING ALUMINUM

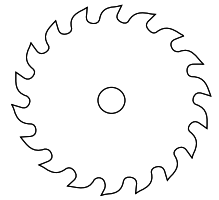

DRILL

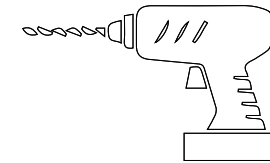

TAPE MEASURE

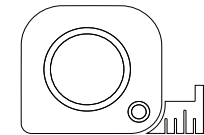

Zintra Sticks Suspension Kit Installation Instructions

STEP 1

USE A LASER LEVEL OR SPIRIT LEVEL TO MARK ALUMINUM POSITION ON THE STANDARD ALUMINIUM TUBE WITHOUT NOTCHES.

MAX DISTANCE FROM TUBE CENTER IS 17.71"

MAX DISTANCE BETWEEN END OF ALUMINIUM TUBE WITHOUT NOTCHES CENTER AND ALUMINIUM TUBE WITH NOTCHES CENTRE IS 0.9"

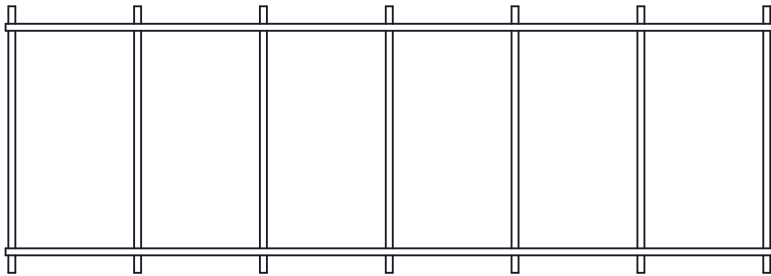

TOP VIEW

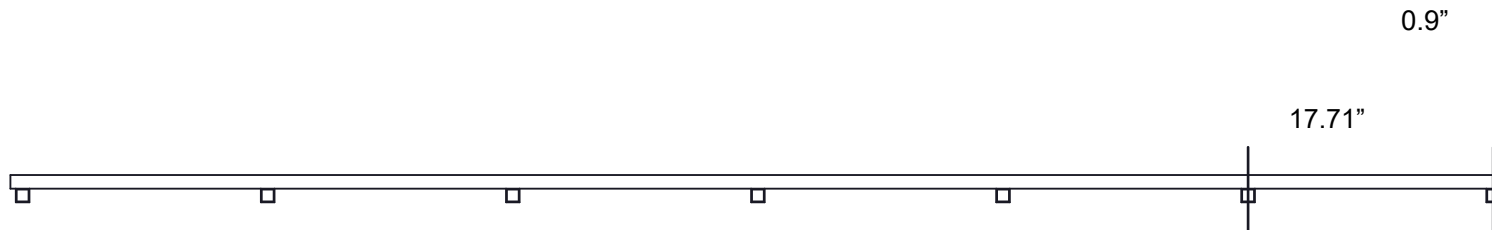
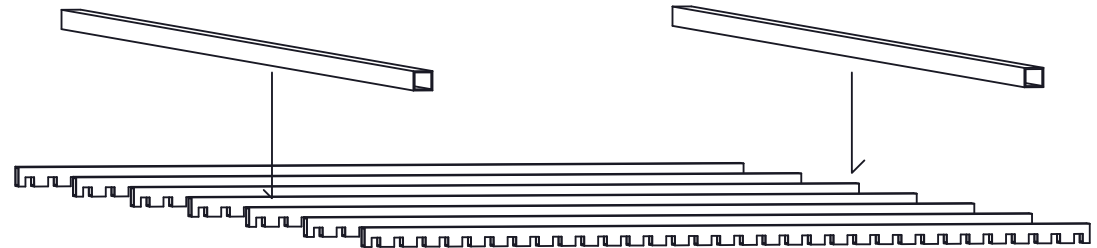

SIDE VIEW

Zintra Sticks Suspension Kit **Installation Instructions**

STEP 2

MAX DISTANCE FROM CROSSRUNNERS CENTER TO EDGE OF ALUMINUM TUBES WITHOUT NOTCHES IS 2.95"

SCREW IN THE ALUMINUM TUBES WITH NOTCHES INTO THE CROSSRUNNERS (ALUMINUM TUBE WITHOUT NOTCHES)

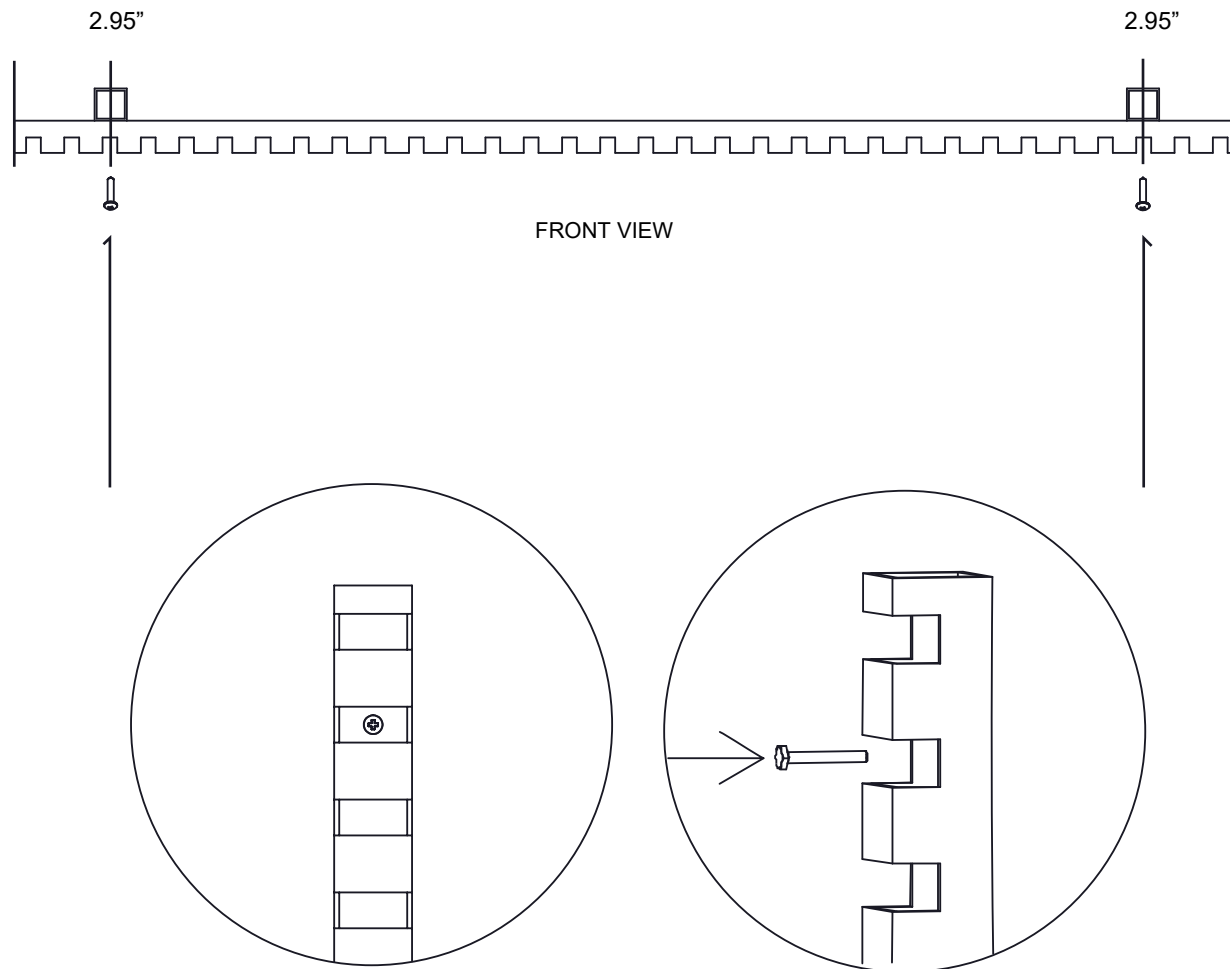

Zintra Sticks Suspension Kit Installation Instructions

STEP 3

INSERT ZINTRA STICKS INTO NOTCHED ALUMINUM TUBES AS SHOWN

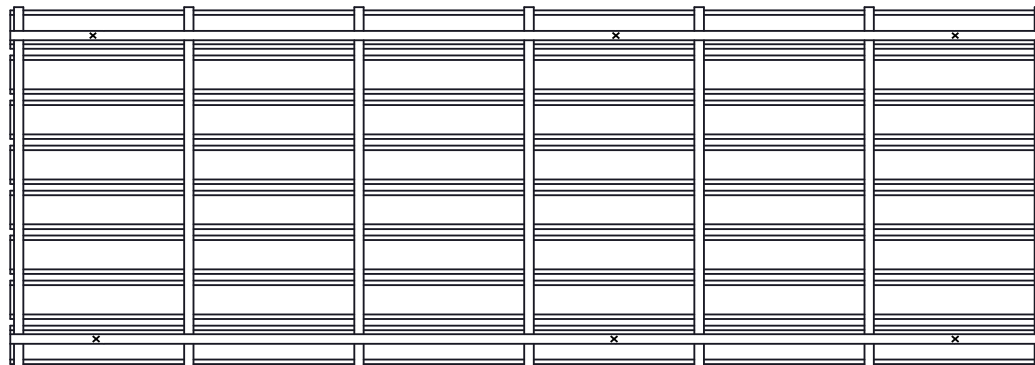
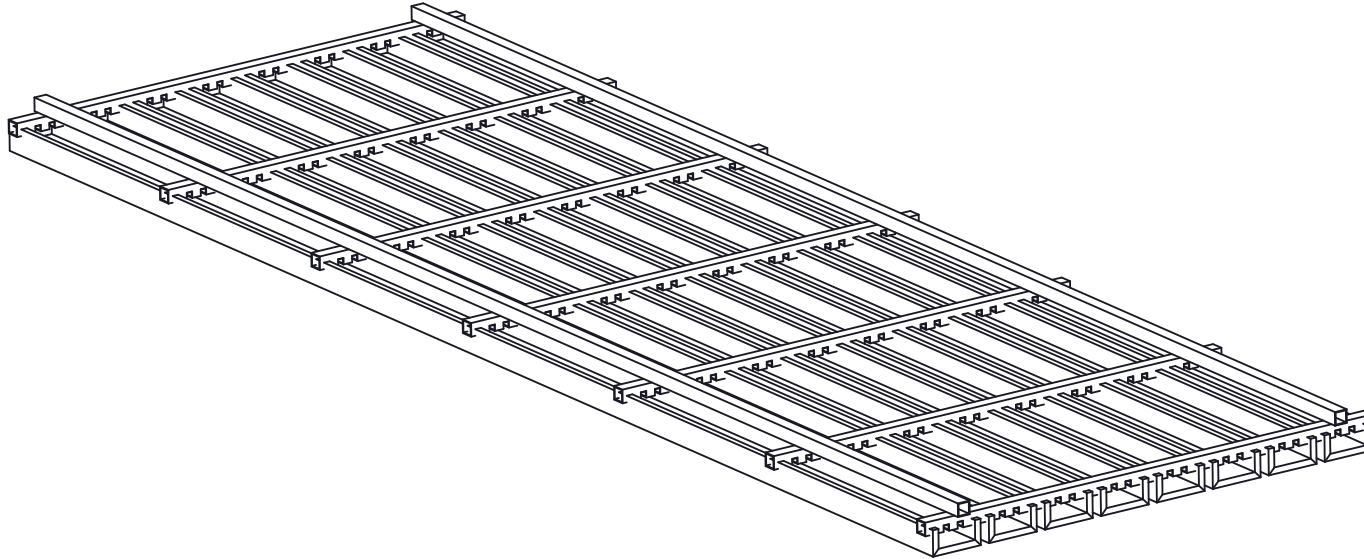

TOP VIEW

Zintra Sticks Suspension Kit Installation Instructions

STEP 4

AFTER IDENTIFYING EACH CORRESPONDING POINT ON THE CEILING SUBSTRATE, TO THE POINTS MARKED ON STEP 3, DRILL AND ATTACH 1/4"-20 DOUBLE SIDED HANGER BOLT TO SUBSTRATE. REFERENCE DETAIL (SUPPLIED FOR WOOD ANCHORING ONLY). FOR ALL OTHER SUBSTRATES, STUDS/ANCHORS MUST BE SOURCED BY THE INSTALLER.

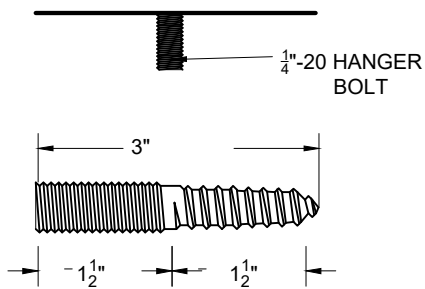

STEP 5

- IDENTIFY THE THREADED END OF THE BARREL AND THE SWAGE END OF THE WIRE.
- INSERT THE PLAIN END OF THE SUPPLIED WIRE THROUGH THE LARGE THREADED END OF THE BARREL UNTIL THE SWAGE END IS SEATED IN THE BARREL.
- ATTACH THE THREADED END OF THE BARREL TO 1 / 4"- 20 HANGER BOLT.

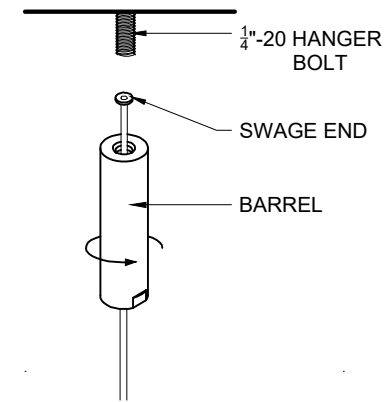

STEP 6

- INSERT THE PLAIN END OF THE SUPPLIED WIRE THROUGH ONE SIDE OF THE ADJUSTABLE FASTENERS.
- LOOP THE WIRE AROUND THE CROSSRUNNER WHERE MARKED.
- RE-INSERT THE PLAIN END OF THE WIRE INTO THE REMAINING SIDE OF THE ADJUSTABLE FASTENER UNTIL SECURE.

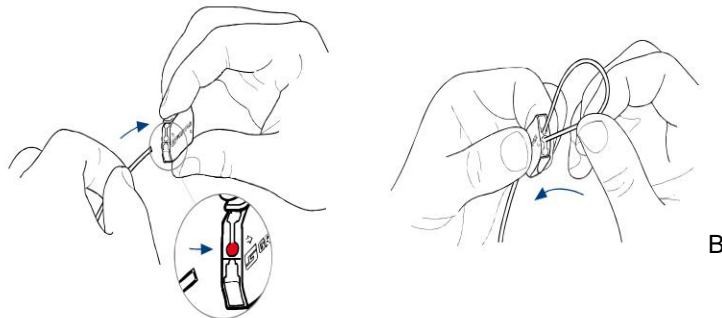

STEP 7

ONCE THE HANGING KIT IS PROPERLY SUSPENDED, TRIM THE EXCESS WIRE (IF NECESSARY) WITH WIRE CUTTERS.

NOTE: WIRE IS INFINITELY ADJUSTABLE BY DEPRESSING TAB ON APPROPRIATE SIDE.

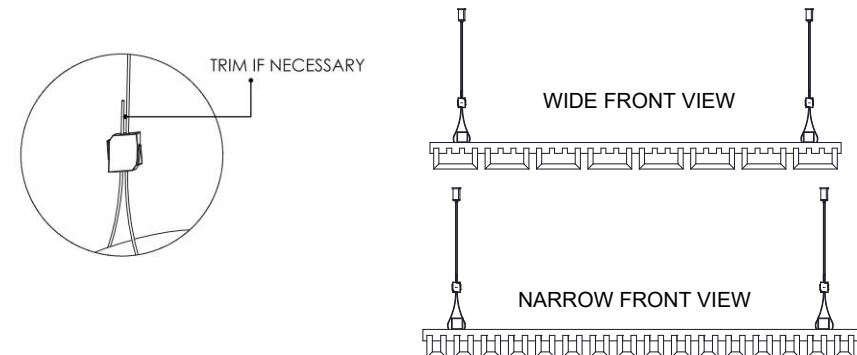

Zintra Sticks Suspension Kit **Installation Instructions**

FINISHED INSTALL

