

MDC  
INTERIOR SOLUTIONS

Zintra Product Catalog | [mdc.is/zintra](http://mdc.is/zintra)

# Design Guide

zintra®  
ACOUSTIC SOLUTIONS



## Beautiful Spaces

Create spaces that look good and sound good.

Zintra's Acoustic Solutions for walls and ceilings enhance the aesthetics of indoor spaces while delivering superior acoustic performance. Available in a wide range of colors, sizes, and fabrication options, Zintra is easy to configure, quick to ship, and simple to install.

 Superior acoustics

 Sustainable

 Lightweight

 Easy installation

 Seamless application

 Digitally printable



Product: Zintra Etch Panel Tesselate | Color: Elderberry & Meadow

# Contents

## 2 Capabilities

- 4 Building a Sustainable Future
- 6 Superior Acoustics
- 9 Your Acoustic Partner
- 10 Color Never Sounded So Good

## 20 Zintra Print

- 22 Premium Wood
- 26 Premium Material
- 30 Zintra Print Art
- 38 Zintra Print Color
- 40 Studio Colors
- 41 Spirit Colors

## 42 Zintra Panels

- 44 1/2" Acoustic Panel
- 45 1" Acoustic Panel
- 46 3D Panel
- 50 Emboss Panel
- 58 Layers Panel
- 62 Pattern Panel
- 70 Etch Panel
- 78 Organic Etch Panel
- 84 Texture Panel
- 88 Sculpted Panel

## 92 Ceiling Features

- 94 Clouds
- 100 Shapes
- 104 Emboss Ceiling Tiles

## 108 Baffles

- 110 Baffle Systems
- 116 Box Baffles
- 120 Mesh Baffles
- 128 Beams
- 134 Connect

## 140 Acoustic Sticks

- 142 Sticks Bundles
- 146 Sticks Corner
- 148 Sticks Transition
- 150 Sticks Trim
- 156 Independent Sticks
- 160 Quadratic Sticks
- 164 Double Sided Sticks
- 168 Curved Sticks

## 172 Tiles

- 174 Plain Tiles
- 180 Box Tiles
- 188 Etch Tiles
- 196 Pattern Tiles

## 204 Hardware

- 206 Floor To Ceiling Screens
- 208 Sliding Screens
- 210 Hardware Options
- 214 Powder Coat Colors

# Capabilities

Zintra Acoustic Solutions delivers design-driven, top-tier acoustic solutions. With an emphasis on refining spaces, our approach centers on improving sound quality, curbing echoes and background noise through the integration of acoustic science into our product development.

Our expert team, based in Australia and the USA, is dedicated to producing products that not only meet global standards but also precisely address your acoustic needs.

## Building a Sustainable Future

We are dedicated to ongoing investment in innovative technologies and materials that pave the way for a sustainable future.

Made from 100% recyclable materials and certified by Declare, GREENGUARD, and HPD, Zintra stands out as the perfect material for the green buildings of today and tomorrow, with its ability to reduce noise levels, minimize indoor air pollutants, and a Class A fire rating.

Our commitment to the environment goes hand in hand with our dedication to human well-being and thoughtfully designed spaces that promote health and comfort.

## Made from 100% recyclable materials

**65%** Post-Consumer recycled content from PET bottles

**35%** Pre-Consumer recycled content from PET chips

**5%** PLA— a bio-based material



Low-levels of volatile organic compounds



Contains no formaldehyde



Global Recycling Standard



# Superior Acoustics

Hybrid working, collaborative learning and evolving social dynamics have driven the need for adaptable open spaces. These spaces often come with poor acoustics, which make it hard to communicate and difficult to concentrate.

The properties of a space - its dimensions, the materials used, and how they are applied - define how sound is transmitted.

The ability of a material to absorb sound is critical to good acoustics, which is calculated as the Noise Reduction Coefficient (NRC), Sound Absorption Average (SAA), and Weighted Sound Absorption Average ( $\bar{\alpha}$ ). Our products are independently tested by third-party test labs that have been certified by The American Society for Testing and Materials (ASTM) and by the International Standards Organization (ISO).

Zintra products have been tested according to ASTM C423-17 and received NRC ratings ranging from 0.45 – 1.10, depending on its depth, shape and the distance it's installed from a surface.

Frequency/Hz	100	125	160	200	250	315	400	500	630	800	1000	1250	1600	2000	2500	3150	4000	SAA	NRC	$\bar{\alpha}$	
zindra 1/2"	0"	0.03	0.01	0.090	0.04	0.05	0.09	0.12	0.25	0.32	0.49	0.61	0.72	0.82	0.85	0.91	0.94	0.95	0.44	0.45	0.30
	2"	0.20	0.16	0.22	0.32	0.46	0.56	0.63	0.80	0.89	1.03	1.04	0.99	1.07	1.00	0.93	0.87	0.92	0.81	0.85	0.75
	6"	0.29	0.46	0.44	0.57	0.69	0.81	0.97	0.96	0.91	1.04	0.92	0.80	0.94	0.94	0.91	0.90	0.91	0.87	0.90	0.95
	12"	0.22	0.22	0.34	0.66	0.73	0.83	0.96	0.91	0.84	0.89	0.98	0.97	1.06	1.13	1.17	1.21	1.21	0.93	0.95	0.95
zindra 1"	0"	0.01	0.04	0.13	0.61	0.77	0.77	0.92	0.98	1.04	1.09	1.00	0.97	0.97	0.96	0.93	1.00	0.99	0.75	0.75	0.60
	2"	0.25	0.36	0.42	0.66	0.69	0.77	0.88	0.99	0.90	0.92	0.86	0.90	0.97	1.00	0.97	0.99	1.00	0.92	0.95	0.95
	6"	0.17	0.12	0.34	0.38	0.63	0.83	0.91	1.10	1.14	1.13	1.06	1.02	1.13	1.14	1.15	1.18	1.14	0.97	1.00	0.90
	12"	0.21	0.26	0.39	0.71	0.77	0.95	0.94	0.93	0.91	1.07	1.19	1.13	1.18	1.21	1.22	1.26	1.25	1.02	1.00	1.00

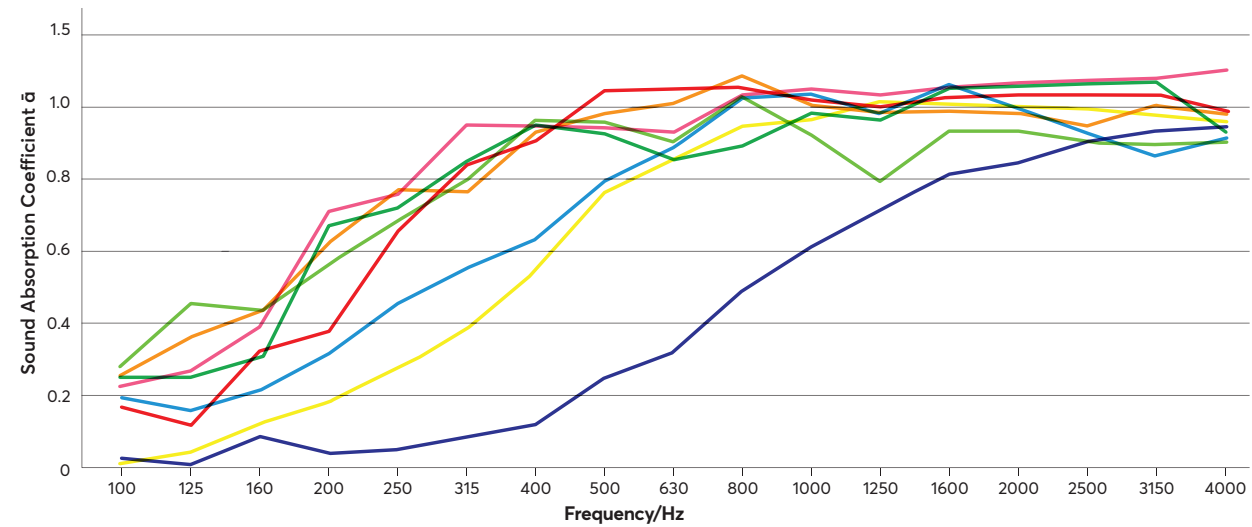

Product: Zintra Box Tile Square  
Color: Parchment and Storm

## Your Acoustic Partner

### Acoustic Consulting Services

Leverage the expertise of our skilled in-house acoustic consultancy to develop creative and quality acoustic solutions tailored to the specific acoustic demands of your space.



In-house  
acoustician



Expert  
Guidance



Tailored  
Solutions



Innovation and  
Creativity

### Project Customization

The Zintra Acoustic Solutions range is fully customizable to meet your design requirements, providing flexibility for any project. Our experienced team of specialist designers, project managers and production are ready to guide you through the process to deliver the best outcomes for your project.



Customization



Branding  
Opportunities



Bespoke  
Design



Expert Support

### Enhanced Project Execution with Work Shop Drawings

Our Work Shop Drawings (WSDs) deliver accuracy and clarity, ensuring manufacturing is precise to specifications and streamlines production with clear guidelines to enhance efficiency. Serving as a quality control benchmark, WSDs guarantee that each project detail meets the highest standards. Additionally, our adherence to industry standards and regulations with our WSDs helps you navigate compliance smoothly and avoid potential issues.



Clarity and  
Precision



Quality  
Control



Streamlined  
Production



Regulatory  
Compliance

### Acoustic Solutions for Diverse Applications

Zintra Acoustic Solutions offers a wide range of products and designs including Panels, Screens, Tiles, Ceiling Baffles and features for various industries including Commercial, Hospitality, Education and Healthcare.

### Domestic Production

Zintra Acoustic Solutions is proud to be fabricated locally for improved quality control, reliability, and quick turnaround. Efficient local processes guarantee fast delivery without sacrificing quality.

Product: Zintra Baffle System Custom Wave  
Color: Ecrú with Satin Black Powder Coat  
Project: Rydges Coolangatta | Designer: Design Nu  
Photographer: AH Photography

## Color Never Sounded So Good

The Zintra Panel colors have been developed with versatility in mind. Craft standalone color statements or select a combination of complementary and contrasting tones for indoor spaces that look exceptional and sound extraordinary.



## Available in 30 Solid Colors + 4 Timber Species

Tar	Slate*	Pewter*
Storm	Greige	Fossil
Pebble*	Smoke	Ivory
Linen	Parchment	Frost*
Grass*	Olive	Malachite
Meadow	Sunshine	Mandarin
Brick	Ochre	Saffron
Elderberry	Bark	Ecru*
Cadet	Twilight	Midnight
Chambray	Sky	Cobalt
Eucalyptus	Ironbark	
Spotted Gum	Merbau	

Timber Species

\* Also available in 24mm (1")  
All colors on this page are stocked products.



## 18 Premium Materials

Recreate the striking aesthetics of architectural finishes with breathtaking realism.



12. Product: Zintra Premium Material | Color: Shale Medium

## 12 Premium Woods

Rich tones and natural grains epitomize our photo realistic wood finishes.

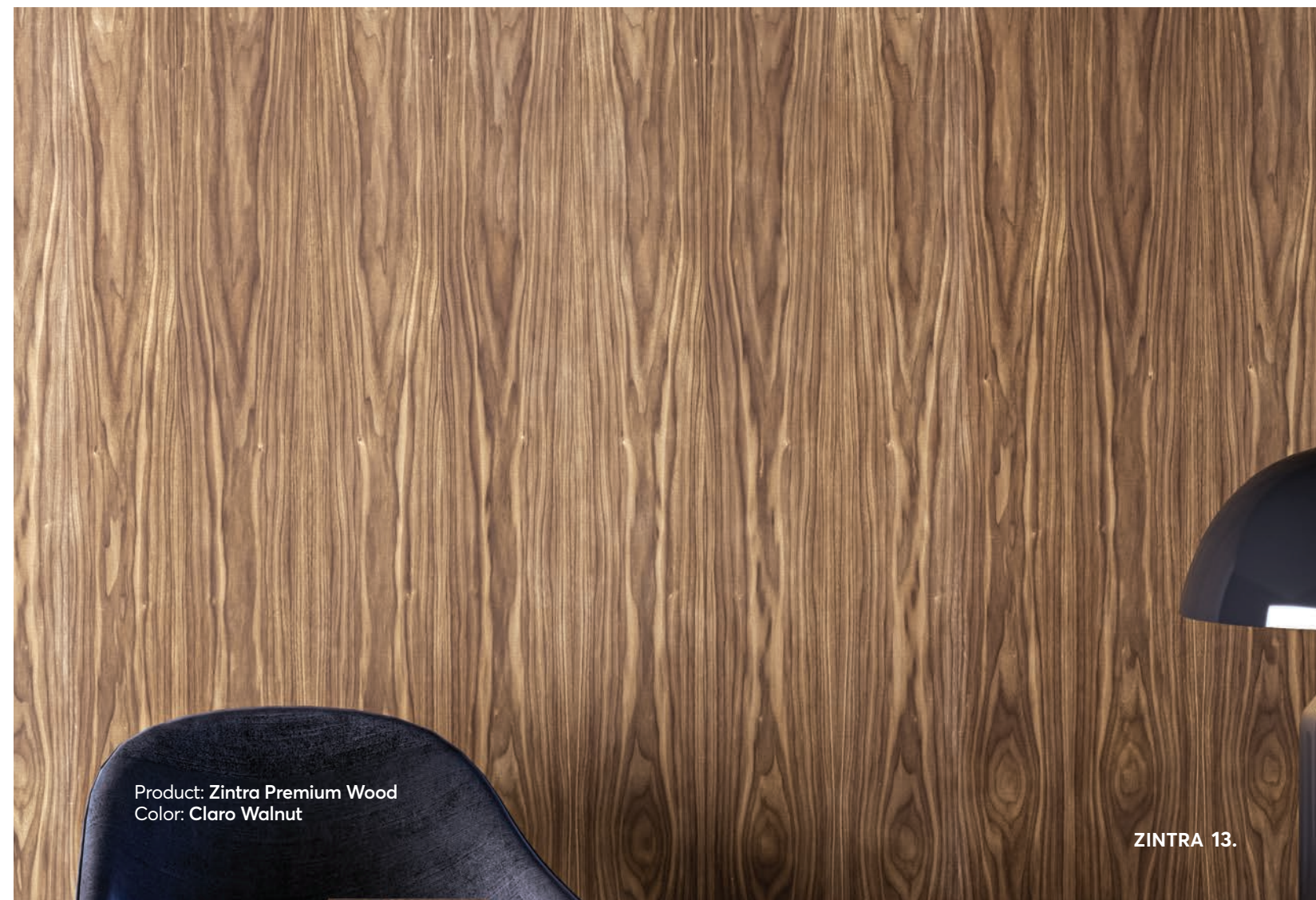

Product: Zintra Premium Wood  
Color: Claro Walnut

ZINTRA 13.

# Earthy Elegance

Ecru

Meadow

Saffron



# Coastal Harmony

Cadet

Linen

Ecru



# Organic Fusion



# Timeless Neutrals



# Bold Statements



Elderberry

Saffron

# Warm and Cozy



Ivory

Bark

Brick

Ecrú

# Zintra Print

Elevate your acoustic panels with our Zintra Print options, blending functionality and artistry. Designed to bring a unique style to your interior space, our offerings – Premium Material, Premium Wood, Print Art, and Print Color – ensure a personalized aesthetic that crafts an environment not only to be seen but truly felt.



Product: Zintra Print Art Abstract,  
20. Igneous Rising Steel | Substrate: Frost

## Premium Wood

Zintra Premium Wood provides a photorealistic, lightweight, and easy-to-fabricate alternative to real wood. It features prints of twelve artisan species from the US and around the world, showcasing rich tones and natural grains that range from mild to wild.

This collection helps bring the outdoors in, allowing you to create warm, inviting, and acoustically minded commercial spaces that connect people with nature. Coordinating base colors have been perfectly paired to enhance a sense of depth and ensure print crispness and clarity that is second to none.

Refer to [page 13](#) for swatches.

Available in 12 designs

Applications



Scan the QR code to find out more

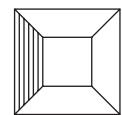

Walls

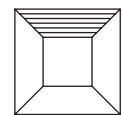

Ceilings





Product: Zintra Premium Wood  
Color: Maple

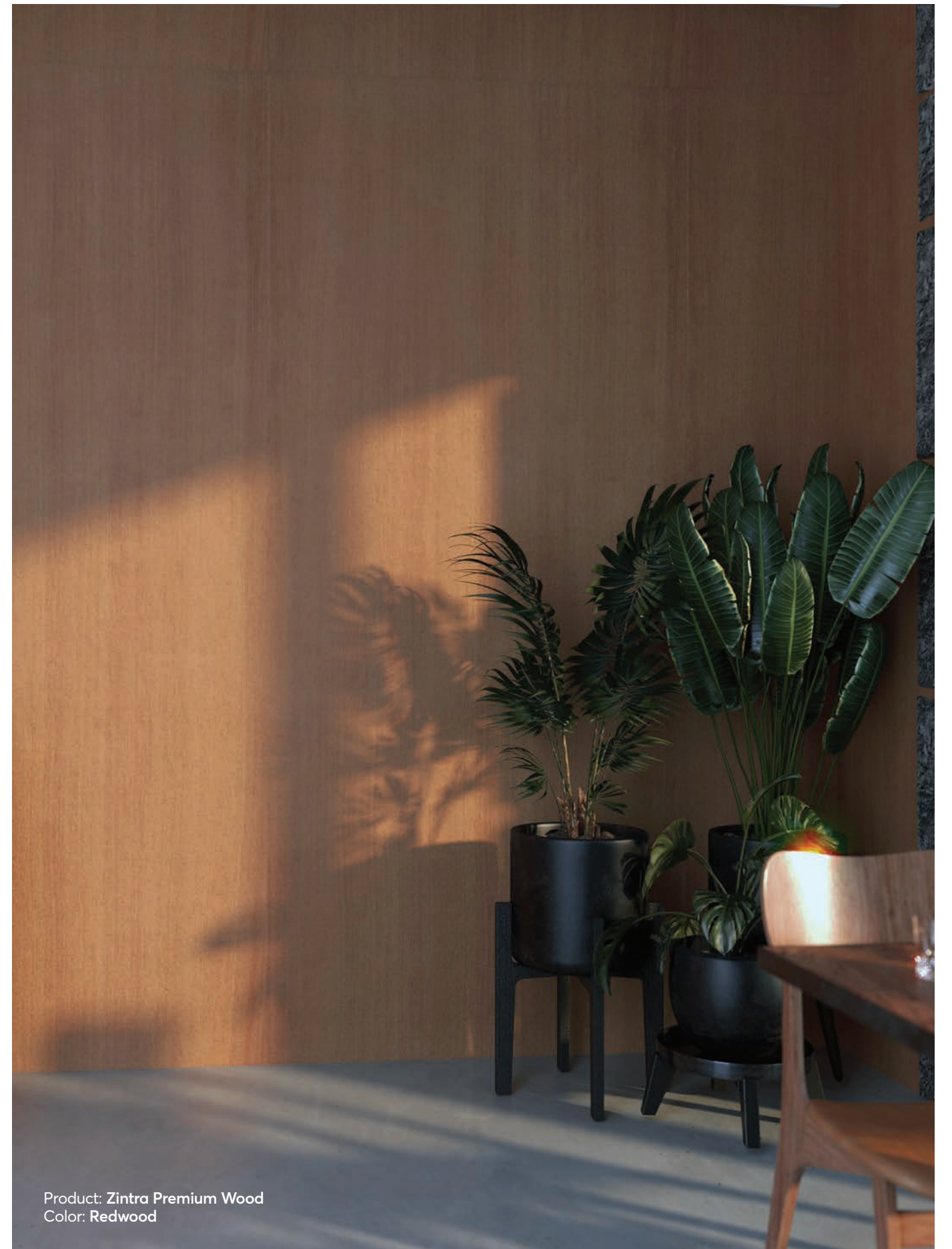

Product: Zintra Premium Wood  
Color: Redwood

## Premium Material

Zintra Premium Material offers individually crafted, photorealistic, lightweight, and easy-to-fabricate architectural finishes, ideal for acoustically minded commercial and hospitality spaces.

Available in a variety of concretes, stones, and terracottas across a range of colors and substrates, Premium Material's coordinating base colors have been expertly paired to add depth and ensure unparalleled print crispness and clarity.

Refer to [page 12](#) for swatches.

Available in 18 designs Applications



Scan the QR code to find out more

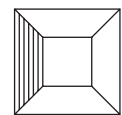

Walls

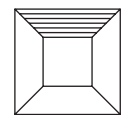

Ceilings







Product: Zintra Premium Material | Color: Shale Medium

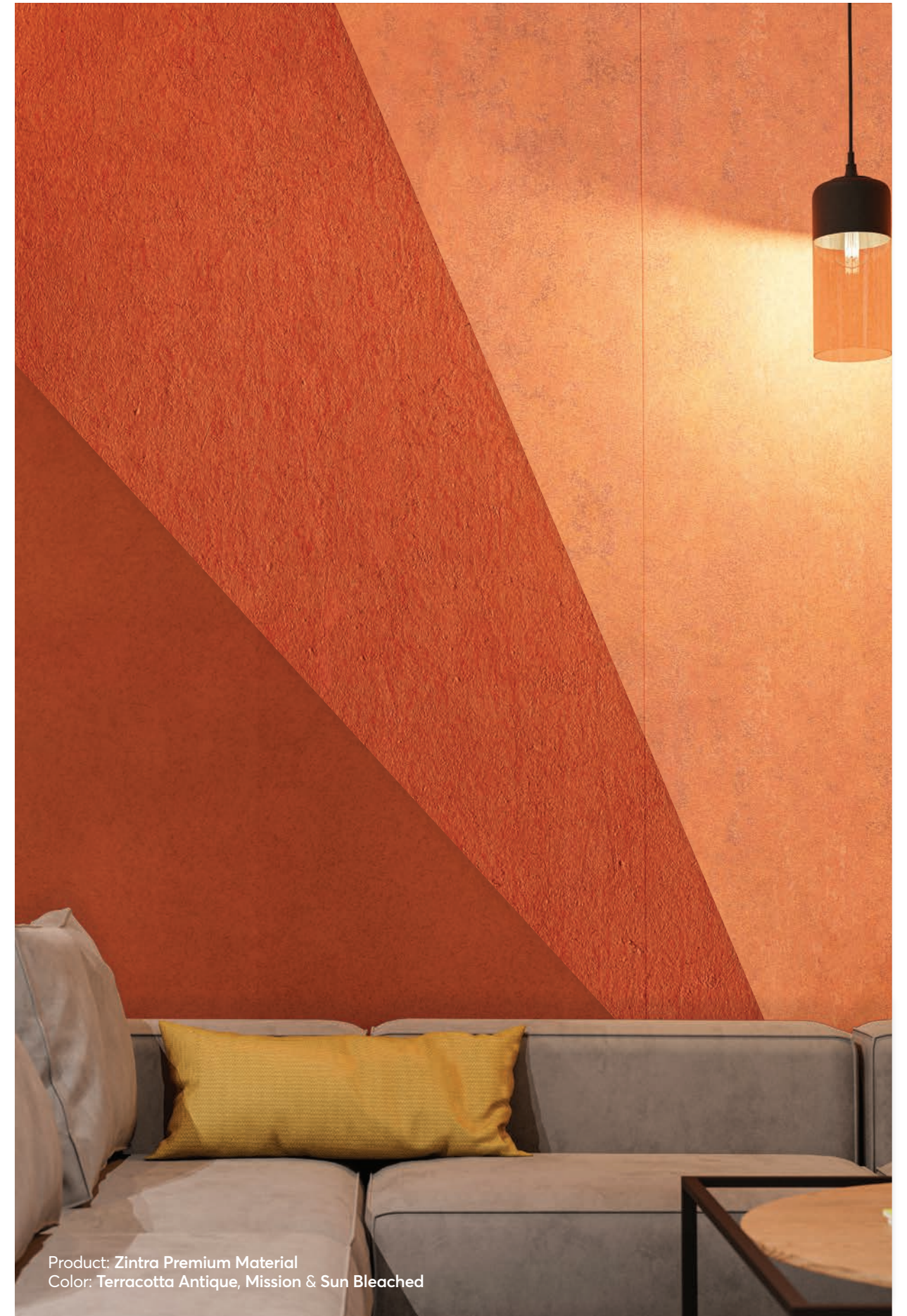

Product: Zintra Premium Material  
Color: Terracotta Antique, Mission & Sun Bleached

# Zintra Print Art

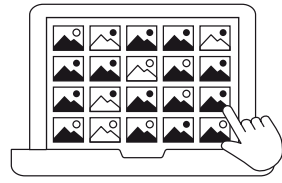

## 1. Choose your Design

Over 300 curated designs in multiple colorways are provided as the inspiration to print on your chosen base color. Zintra Print Art includes a Materials collection, featuring Timber, Metal, Stone and Concrete prints, and an Artwork collection, incorporating Abstract, Botanical and Geometric designs. In addition, we have partnered with internationally renowned artists to provide unique content for your space.

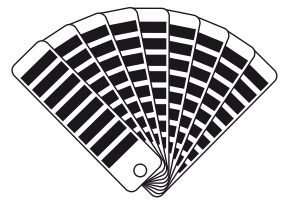

## 2. Choose your Base

Print onto the entire Zintra Acoustic 1/2" (30 colors) and 1" (6 colors) panel range. While the color of the Zintra base will impact the color of the print, it's easy to print a layer of white before the color layer to deliver color accuracy.

See p.44 and 45.

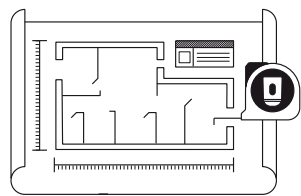

## 3. Define your Space

The Zintra Print Art offer is made to order to suit your project. Provide us with the sizing and layout required to specifically fit your space and the Zintra Print panels will be provided to size, ready for install.

Available in over 300 designs



Scan the QR code to find out more

### Applications

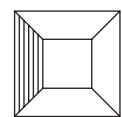

Walls

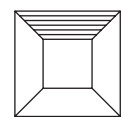

Ceilings



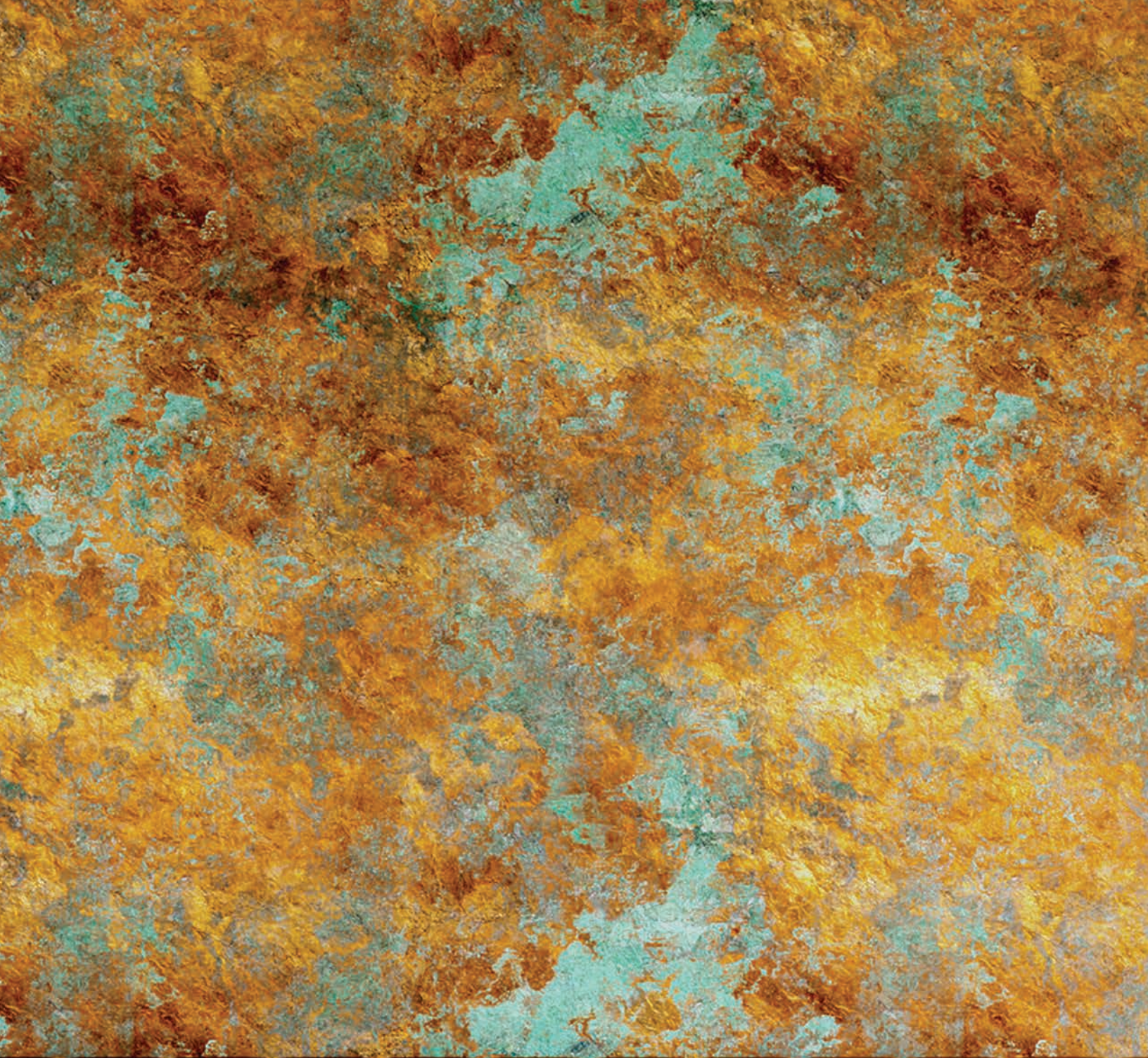

Product: Zintra Print Art Metals, Stone & Concrete,  
Vintage Bronze | Substrate: Frost



Product: Zintra Print Art Timber,  
Wooden Herringbone | Substrate: Frost



Product: Zintra Print Art Murals,  
Salt Lake | Substrate: Frost



Product: Zintra Print Art Abstract,  
Earthy Ways | Substrate: Frost



Product: Zintra Print Art In the Wild,  
Flying Feathers | Substrate: Frost

**reception**



Product: Zintra Print Art Botanicals,  
Into the Jungle | Substrate: Frost



Product: Zintra Print Art Lines & Geometrics,  
French Linen Duck Egg | Substrate: Frost

# Zintra Print Color

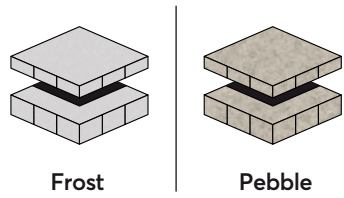

## 1. Choose your Base

Frost and Pebble have been chosen to offer contrasting base panels in both 1/2" and 1". Frost gives a clean, crisp aesthetic with the most accurate color matching, while Pebble offers a softer, more muted aesthetic with a heathered effect.

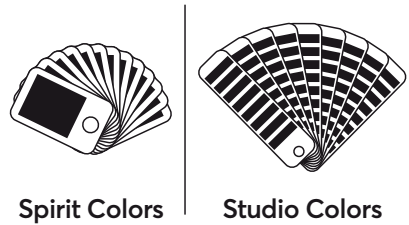

## 2. Choose your Color

We've carefully chosen a broad, contemporary color palette to expand the range. 56 Studio colors reflect the latest interior design trends, while 10 Spirit colors are bolder and more vibrant, to showcase your school or team brand.

See p.40 and 41.

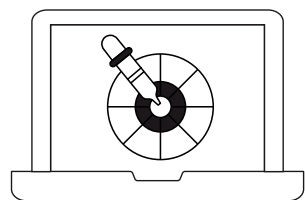

## 3. Create your Own

If one of the 66 Zintra Print colors doesn't quite meet your brief, it's quick and easy to create your own. Simply give us the Pantone color you're trying to match, and we will create a sample for you.

Available in 66 designs Applications



Scan the QR code to find out more

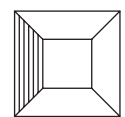

Walls

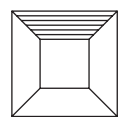

Ceilings



# Studio Colors

56 soft colors to reflect the latest interior design trends.

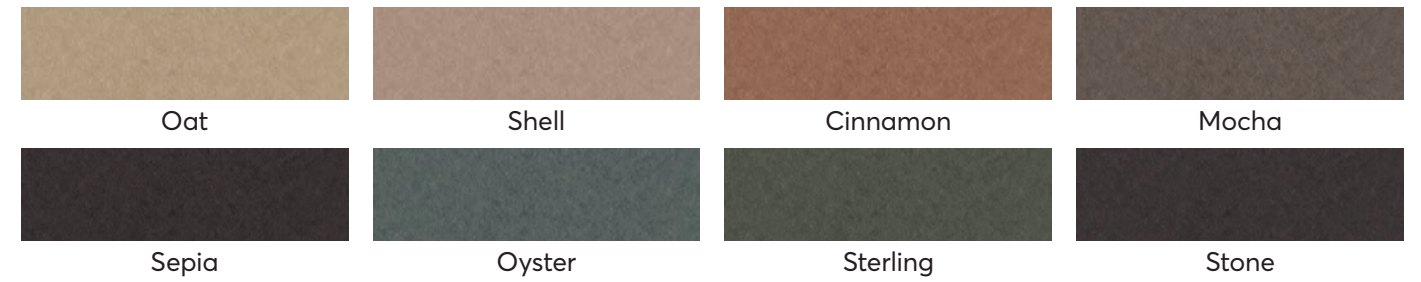

# Spirit Colors

10 vibrant colors to showcase your school or college.



# Edge Banding

The Zintra Print range offers the unique ability to create low-volume colored edge banding. The edge banding is available in the full range of Studio and Spirit colors, or we can easily customize the color for you.

Edge banding can be used to match or contrast the printed surface on selected Zintra Acoustic Solutions.



# Zintra Panels

Experience the perfect synergy of acoustic excellence and visual elegance with Zintra Acoustic Panels. Ideal for commercial, hospitality, and institutional projects, Zintra Acoustic Panels offer a diverse range of aesthetics. Crafted from 100% recyclable materials, Zintra Panels boast exceptional sound absorption capabilities for walls, ceilings, and screens.



Product: Zintra Plain Panel  
42. Color: Saffron & Elderberry





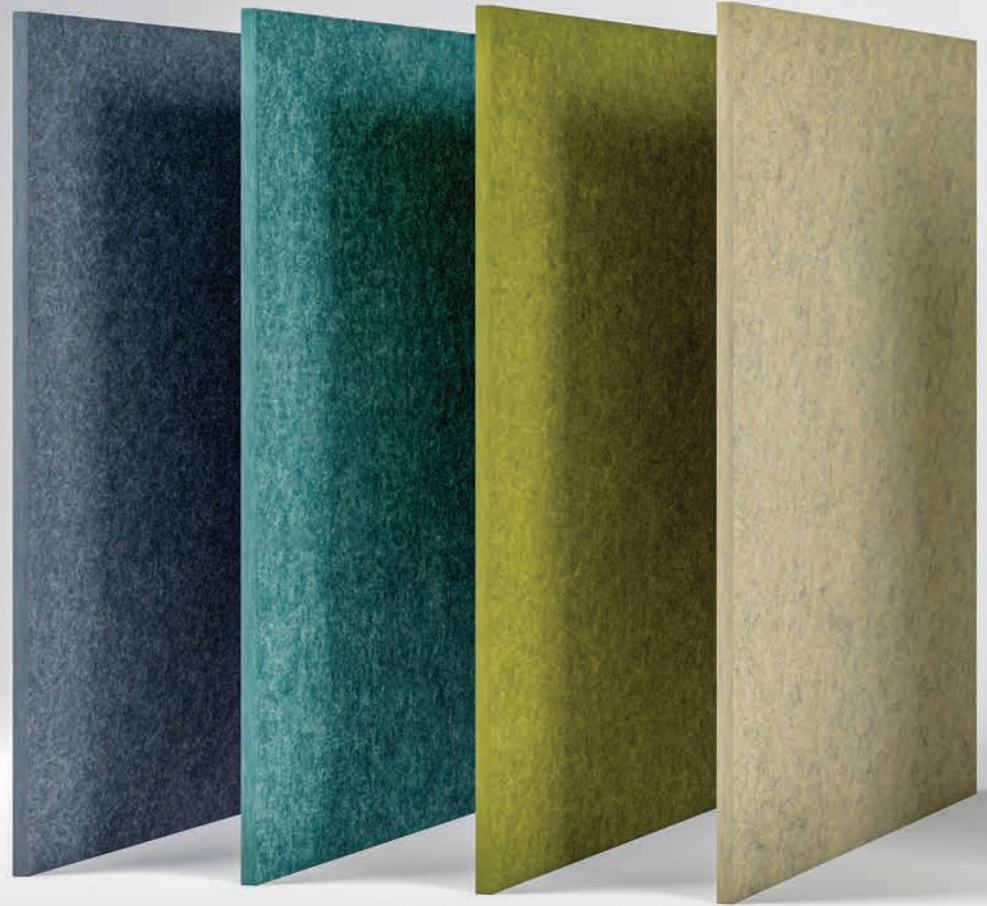

## 1/2" Acoustic Panel

Zintra 1/2" Panel boasts exceptional sound absorption capabilities for walls and ceilings. Use it as is or fabricate it into a designed solution. Measuring 110" (2800mm) in length, these join-free panels are easy to fabricate and install. Choose from a palette of 30 solid colors and 4 timber prints, ensuring effortless integration into any space.

### Specifications

Dimensions	48" (1219mm) x 108" (2743mm) x 1/2" (12mm)		
Colors	Available in all 64 Colors, including Zintra Timber and Premium Prints. See <a href="#">p.11</a> , <a href="#">p.12</a> and <a href="#">p.13</a>		
NRC Rating	Directly Mounted: 0.45	With 2" (50mm) Air Gap: 0.85	With 6" (152mm) Air Gap: 0.90
Aw Rating	Directly Mounted: 0.30	With 2" (50mm) Air Gap: 0.75	With 6" (152mm) Air Gap: 0.95
Suggested Installation	Adhere to substrate using contact adhesive or Liquid Nails. Panel can be mechanically fixed using details similar to glass fittings. Check out the Technical Documents on our website to download the Installation Guide for more details.		
Additional Comments	Also available with Digital Print. Not suitable as a free standing product.		
Customization	The Zintra Acoustic Solutions range is customizable to your project. Please get in touch with your local contact for details.		

Available in all 64 Colors



### Applications

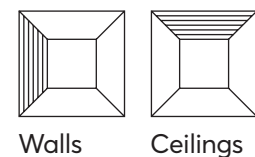

## 1" Acoustic Panel

Zintra 1" Panel boasts exceptional sound absorption capabilities for walls and ceilings. Use it as is or fabricate it into a designed solution. Measuring 110" (2800mm) in length, these join-free panels are easy to fabricate and install. Choose from a palette of 6 solid colors ensuring effortless integration into any space.

### Specifications

Dimensions	48" (1219mm) x 108" (2743mm) x 1" (24mm)		
Colors	Available in all 6 Solid Colors. Shown below.		
NRC Rating	Directly Mounted: 0.75	With 2" (50mm) Air Gap: 0.95	With 6" (152mm) Air Gap: 1.00
Aw Rating	Directly Mounted: 0.60	With 2" (50mm) Air Gap: 0.95	With 6" (152mm) Air Gap: 0.90
Suggested Installation	Adhere to substrate using contact adhesive or Liquid Nails. Panel can be mechanically fixed using details similar to glass fittings. Check out the Technical Documents on our website to download the Installation Guide for more details.		
Additional Comments	Also available with Digital Print. Not suitable as a free standing product.		
Customization	The Zintra Acoustic Solutions range is customizable to your project. Please get in touch with your local contact for details.		

Available in 6 Colors



### Applications

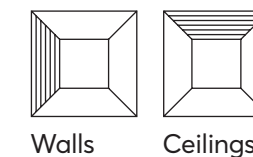

Available Colors



## 3D Panel

Zintra 3D Panel adds a simple yet captivating design element to both straight or curved walls while also enhancing acoustics.

With a narrow panel design and the ability to be cut on site, these panels make wall-to-wall fitting effortless and eliminate the need for custom drawings.

Available in 2 designs



Scan the QR code to find out more

Applications

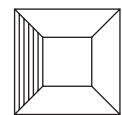

Walls





Product: Zintra 3D Panel Batten 2, 4 and 6 | Color: Meadow

### Peaks

3 strips / set, 26.3 SF (2.4m<sup>2</sup>)  
12" (305mm) w x 108.1" (2745mm) h x 1.6" (40mm) d / strip

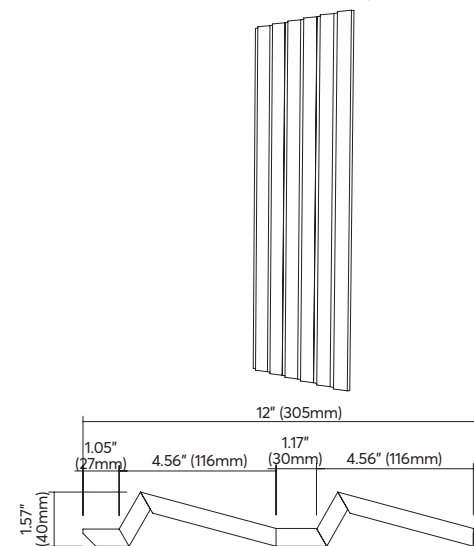

### Batten 2

3 strips / set, 18.1 SF (1.7m<sup>2</sup>)  
8.6" (218mm) w x 108.1" (2745mm) h x 1.5" (37mm) d / strip

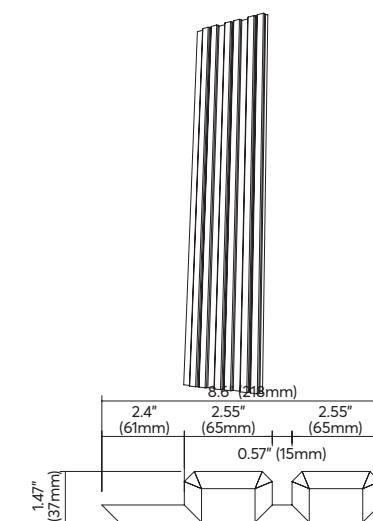

### Batten 4

3 strips / set, 27 SF (2.5m<sup>2</sup>)  
12" (305mm) w x 108.1" (2745mm) h x 1.5" (37mm) d / strip

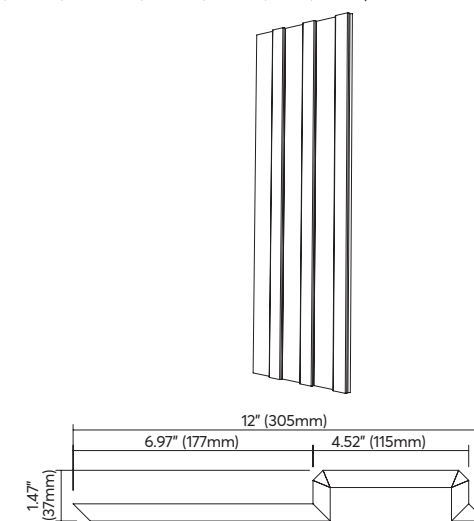

### Batten 6

3 strips / set, 27 SF (2.5m<sup>2</sup>)  
12" (305mm) w x 108.1" (2745mm) h x 1.5" (37mm) d / strip

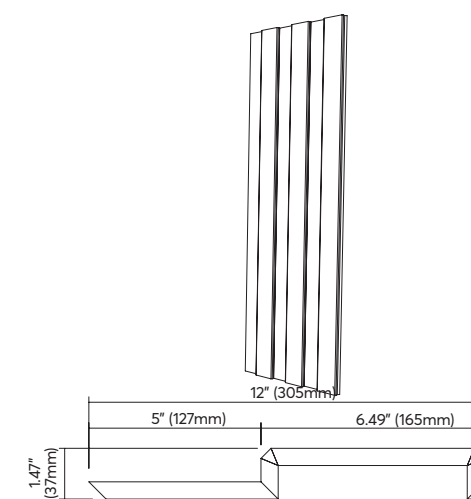

### 3D Panel Specifications

Dimensions	See above.
Colors	Available in all 64 Colors, including Zintra Timber and Premium Prints. See <a href="#">p.11</a> , <a href="#">p.12</a> and <a href="#">p.13</a>
NRC Rating	Directly Mounted: 0.45
Aw Rating	Directly Mounted: 0.30
Suggested Installation	Refer to install guide for staple locations (staples not included). Apply adhesive to the flat surface of the wall panel, then staple inside the groove to secure. Repeat in a tile like fashion across space. Check out the Technical Documents on our website to download the Installation Guide for more details.
Additional Comments	Not suitable as a free standing product.
Customization	The Zintra Acoustic Solutions range is customizable to your project. Please get in touch with your local contact for details.

# Emboss Panel

Zintra Emboss introduces a touch of luxury with its tactile, three-dimensional designs, making it perfect for spaces that demand both noise absorption and aesthetic warmth.

Emboss' consistent patterns allow for seamless installation in all 4 directions, effortlessly crafting a visually captivating atmosphere.

Available in 18 designs



Scan the QR code to find out more

Applications

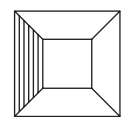

Walls

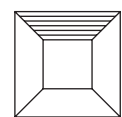

Ceilings





Product: Zintra Emboss Panel  
Celium | Color: Ecrú



Product: Zintra Emboss Panel  
Stitched | Color: Midnight



54. Product: Zintra Emboss Panel Rivulet | Color: Olive



Product: Zintra Emboss Panel  
Constellation | Color: Mandarin

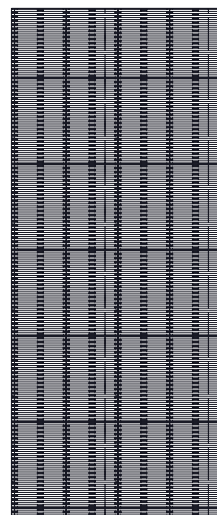

Ascend

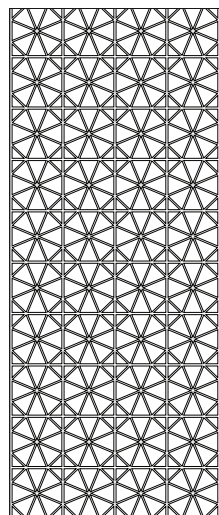

Constellation\*

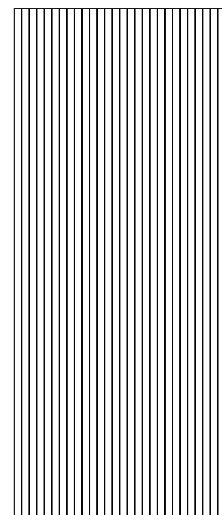

Corduroy\*

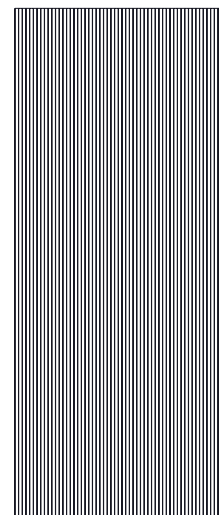

Corduroy Fine

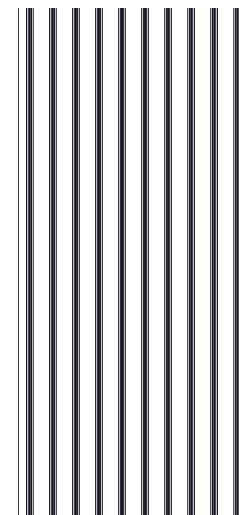

Scallop

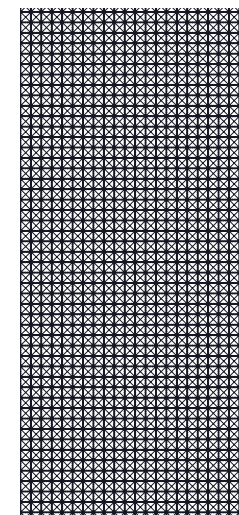

Stitched

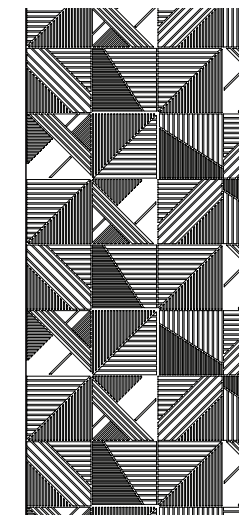

Tapestry\*

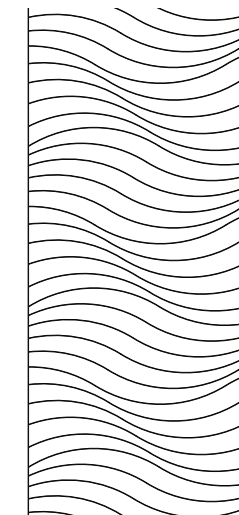

Tidal\*

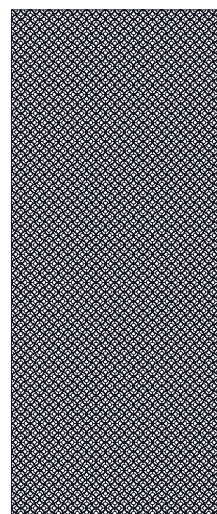

Celium

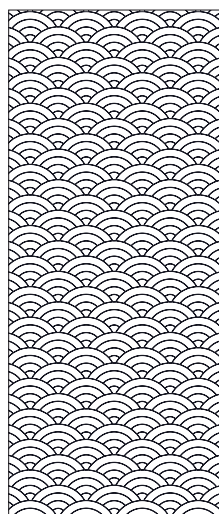

Cumulus\*

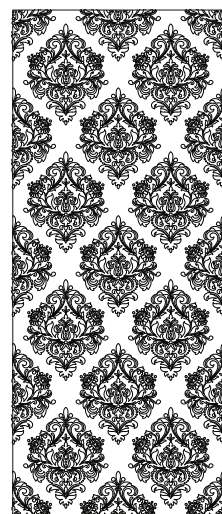

Damask\*



Jungle\*

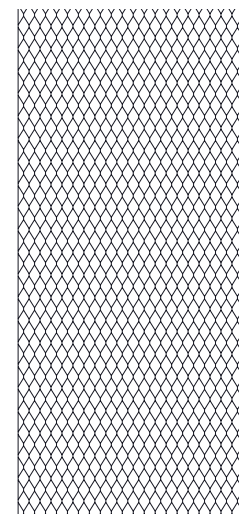

Tufted

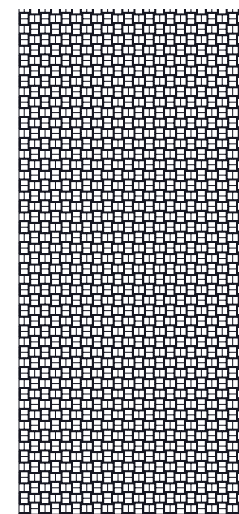

Woven

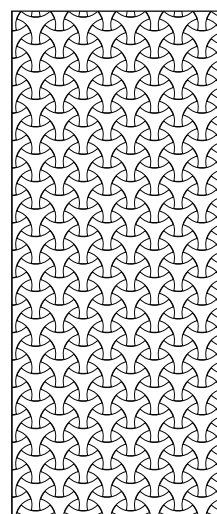

Linked\*

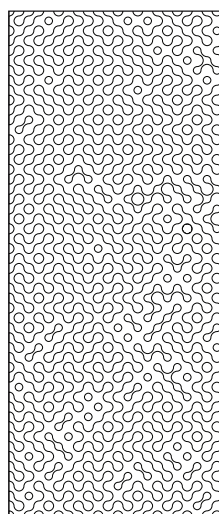

Molecular\*

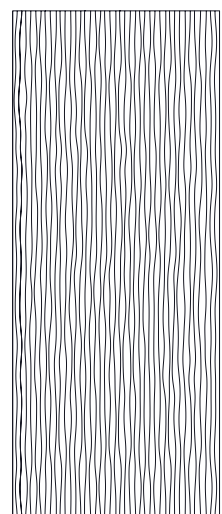

Rivulet

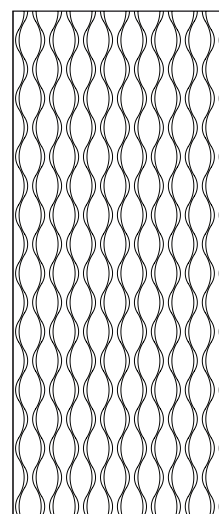

Sandglass\*

### Emboss Panel Specifications

Dimensions	44" (1118mm) x 108" (2743mm)		
Colors	Available in all 64 Colors, including Zintra Timber and Premium Prints. See p.11, p.12 and p.13		
NRC Rating	Directly Mounted: 0.35	With 2" (50mm) Air Gap: 0.65	With 6" (152mm) Air Gap: 0.80
Aw Rating	Directly Mounted: 0.30	With 2" (50mm) Air Gap: 0.60	With 6" (152mm) Air Gap: 0.75
Suggested Installation	Adhere to substrate using contact adhesive or Liquid Nails. Check out the Technical Documents on our website to download the Installation Guide for more details.		
Additional Comments	Zintra Emboss Panels are only suitable for single sided applications. *These designs are also available as 23.7" (600mm) x 23.7" (600m) Tiles.		
Customization	The Zintra Acoustic Solutions range is customizable to your project. Please get in touch with your local contact for details.		

## Layers Panel

Zintra Layers delivers simplistic style and sound absorption with ease.

Whether you're aiming for a dramatic splash with vibrant strips of Layers, or a more subtle touch with the monochrome of Layers 3D, Layers offers a solution that is versatile, visually striking, and acoustically superior, with an NRC of 0.75 when adhered directly to the wall.

Available in 2 designs



Scan the QR code to find out more

Applications

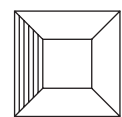

Walls







Product: Zintra Layers Panel 3D  
Color: Grass

### Layers 3D

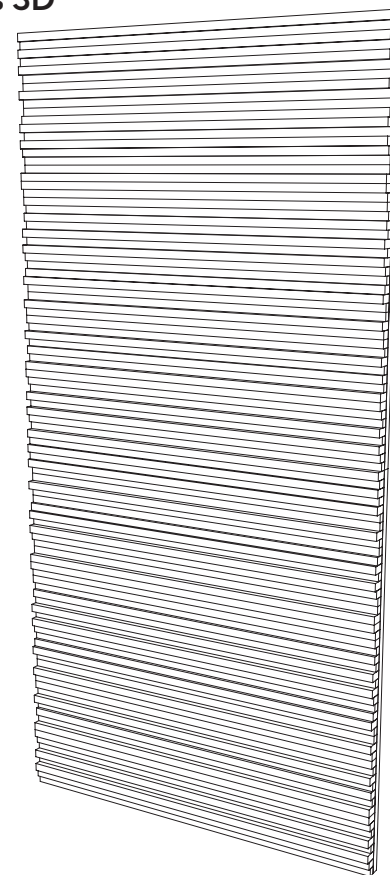

### Layers

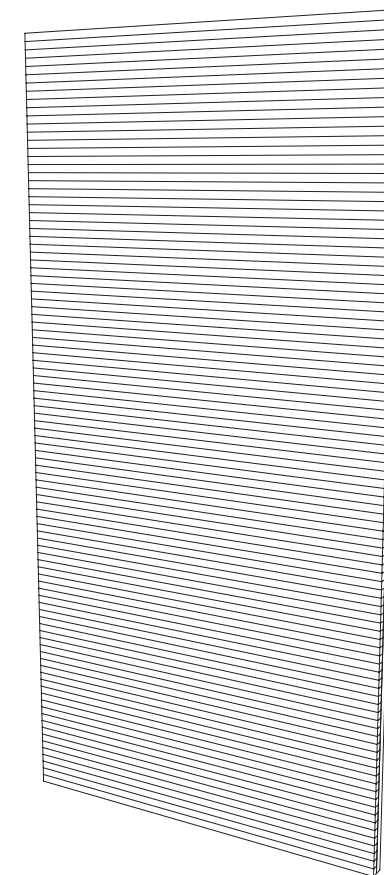

### Layers Panel Specifications

Dimensions	48" (1219mm) x 108" (2743mm)			
Colors	Available in all 64 Colors, including Zintra Timber and Premium Prints. See <a href="#">p.11</a> , <a href="#">p.12</a> and <a href="#">p.13</a>			
NRC Rating	Directly Mounted: 0.75	With 2" (50mm) Air Gap: 0.95	With 6" (152mm) Air Gap: 1.00	With 12" (305mm) Air Gap: 1.00
Aw Rating	Directly Mounted: 0.60	With 2" (50mm) Air Gap: 0.95	With 6" (152mm) Air Gap: 0.95	With 12" (305mm) Air Gap: 1.00
Suggested Installation	Adhere to substrate using contact adhesive, Liquid Nails or Z Clips. Panel can be mechanically fixed. Check out the Technical Documents on our website to download the Installation Guide for more details.			
Additional Comments	As Zintra Layers are hand-made, an exact pattern match from one panel to the next is not possible. All Zintra Layers are supplied on a Zintra Acoustic backer in Black.			
Customization	The Zintra Acoustic Solutions range is customizable to your project. Please get in touch with your local contact for details.			

## Pattern Panel

Zintra Pattern offers a broad and varied range of intricately cut designs, from classic to contemporary.

Use as is with one of our hardware options as a screen, or pair with a matching or contrasting solid Zintra backer for use as multi-dimensional, unique wall cladding.

Available in 51 designs



Scan the QR code to find out more

Applications

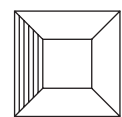

Walls

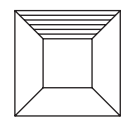

Ceilings





64. Product: Zintra Pattern Panel Lost | Color: Parchment



Product: Zintra Pattern Panel  
Circuit | Color: Greige

ZINTRA 65.

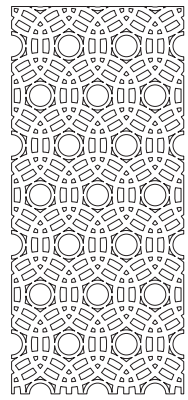

**Abhaya**

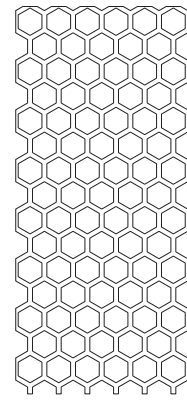

**Asiatic**

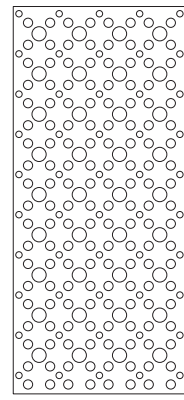

**Astra**

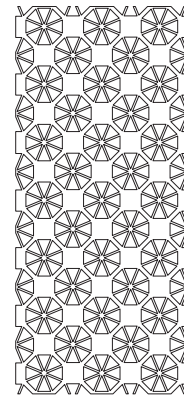

**Bengal**

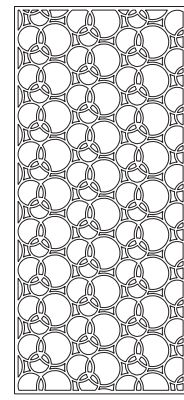

**Bharata\***

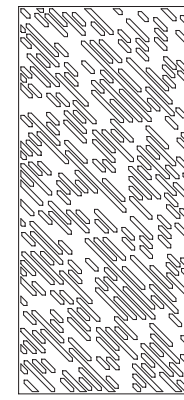

**Garden Art**

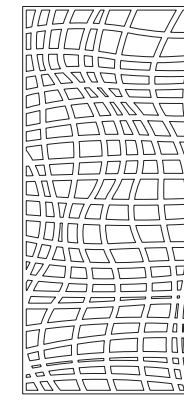

**Haimati\***

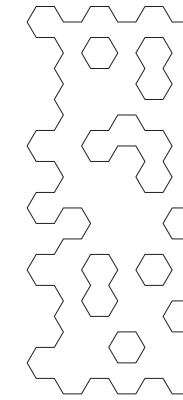

**Hex\***

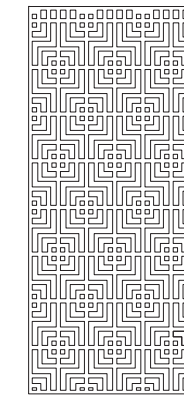

**Indus**

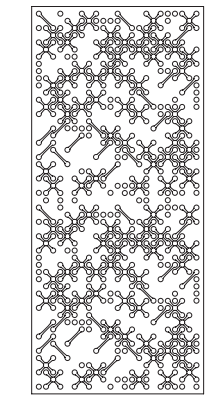

**Jacks\***

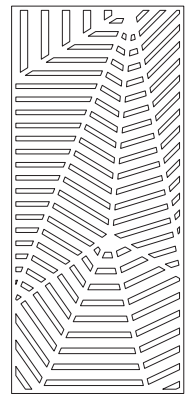

**Bhushan\***

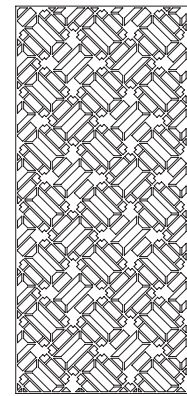

**Circuit**

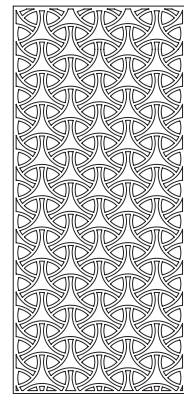

**Cirque**



**Deepak**

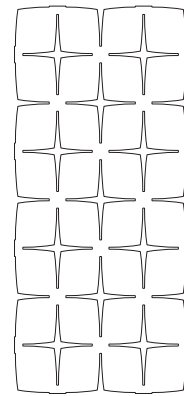

**Devraj**

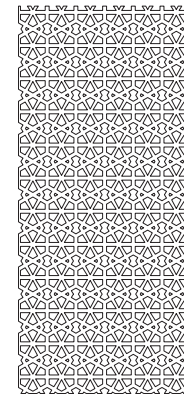

**Kali**

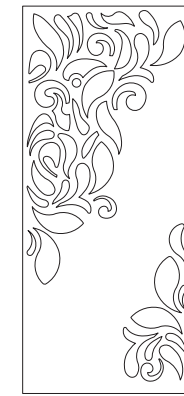

**Kerala\***

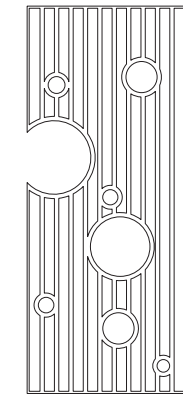

**Krishnan\***

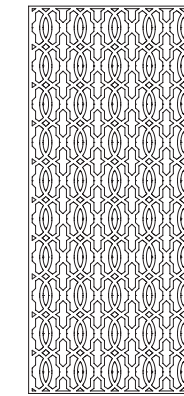

**Links**

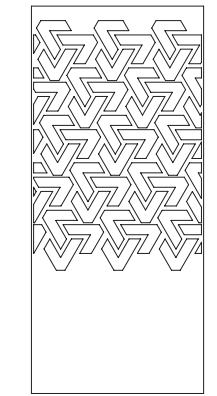

**Lost\***

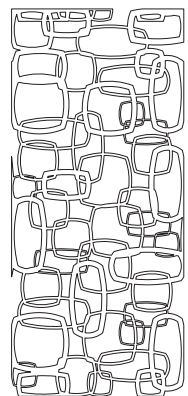

**Elephanta\***

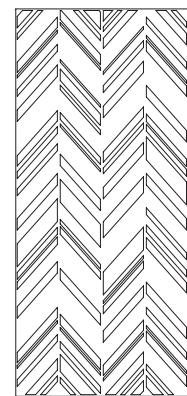

**Fishbone\***

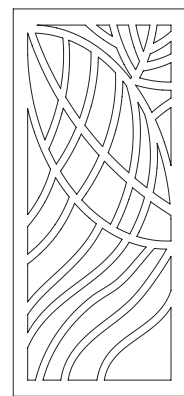

**Foliage\***

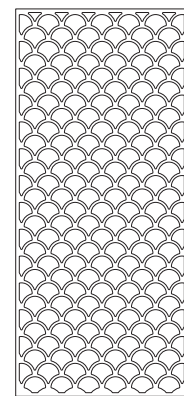

**Gadiva**



**Ginkgo**

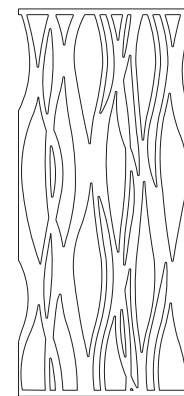

**Mandava\***



**Malini**

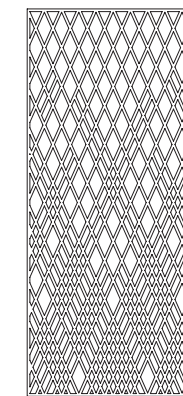

**Marquise\***

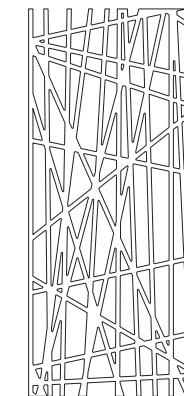

**Monsoon\***

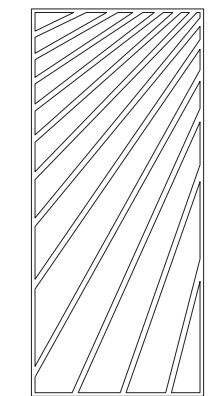

**Nadu\***

\*Available in an A/B configuration and/or A/A-Reverse configuration. See Product Drawings for details

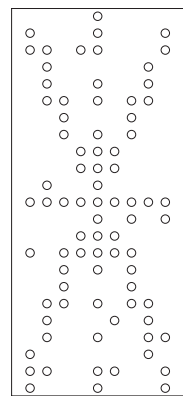

Noktalar

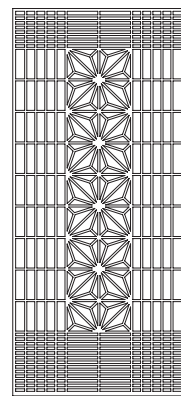

Origami

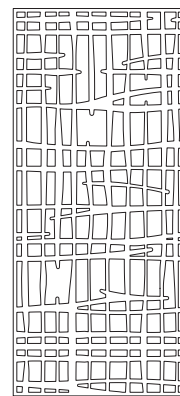

Padmesh\*

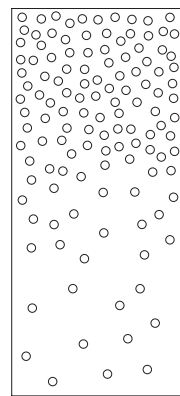

Perdita\*

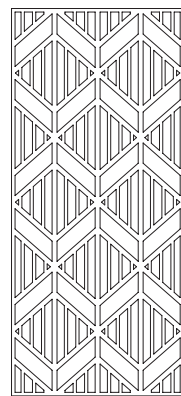

Pivot

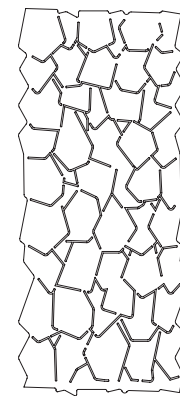

Stone Age

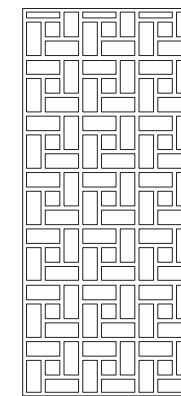

Sutra

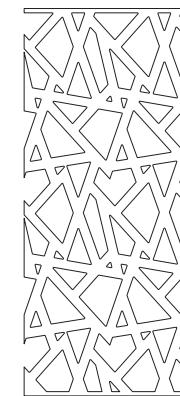

Telugu\*

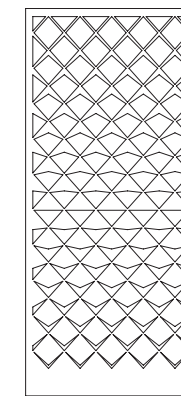

Vanishing

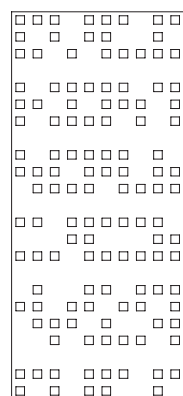

Pixel\*

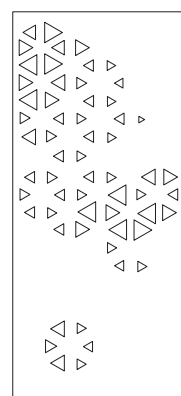

Prose\*

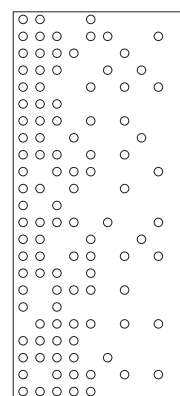

Punto\*

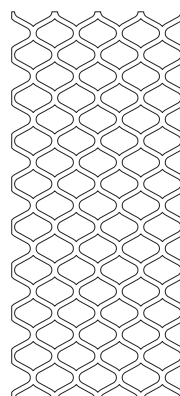

Raja

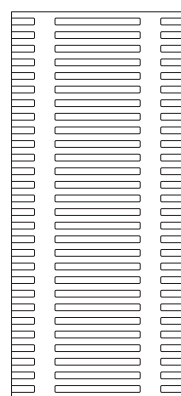

Sakra

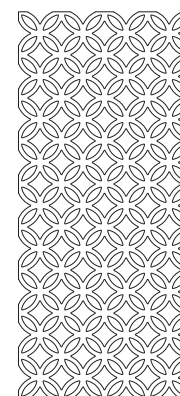

Vedic

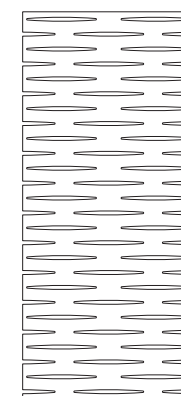

Wamika

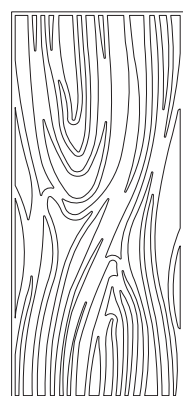

Sankaran\*

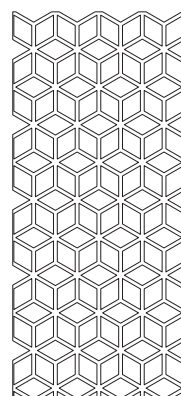

Sanskrit

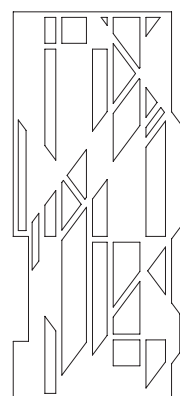

Setro\*

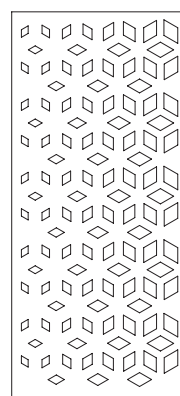

Shard\*

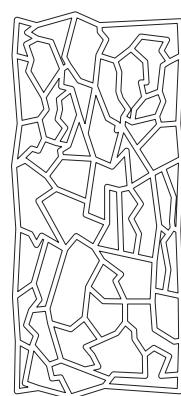

Siptical\*

### Pattern Panel Specifications

Dimensions	PATTERN ONLY 48" (1219mm) x 108" (2743mm) x 1/2" (12mm)		PATTERN ON BACKER 48" (1219mm) x 108" (2743mm) x 1" (24mm)	
Colors	Available in all 64 Colors, including Zintra Timber and Premium Prints. See p.11, p.12 and p.13			
PATTERN ONLY NRC Rating	Directly Mounted: 0.45	With 2" (50mm) Air Gap: 0.85	With 6" (152mm) Air Gap: 0.90	With 12" (305mm) Air Gap: 0.95
Aw Rating	Directly Mounted: 0.30	With 2" (50mm) Air Gap: 0.75	With 6" (152mm) Air Gap: 0.95	With 12" (305mm) Air Gap: 0.95
PATTERN ON BACKER NRC Rating	Directly Mounted: 0.75	With 2" (50mm) Air Gap: 0.95	With 6" (152mm) Air Gap: 1.0	With 12" (305mm) Air Gap: 1.0
Aw Rating	Directly Mounted: 0.60	With 2" (50mm) Air Gap: 0.95	With 6" (152mm) Air Gap: 0.95	With 12" (305mm) Air Gap: 0.95
Suggested Installation	Zintra Pattern Only: Choose from one of our hardware options or choose your own to install as a room divider, ceiling tile or wall/ceiling feature. Zintra Pattern on Backer: Adhere to substrate using contact adhesive or Liquid Nails. Panel can be mechanically fixed using details similar to glass fittings. Check out the Technical Documents on our website to download the Installation Guide for more details.			
Additional Comments	Not suitable as a free standing product. Must define panel configurations for patterns with multiple options when ordering.			
Customization	The Zintra Acoustic Solutions range is customizable to your project. Please get in touch with your local contact for details.			

\*Available in an A/B configuration and/or A/A-Reverse configuration. See Product Drawings for details

## Etch Panel

Zintra Etch brings dynamic 3D designs and subtle textures to commercial, hospitality, and institutional interiors, offering both cutting-edge aesthetics and superior acoustic performance.

Crafted from a subtle 1/8" (3mm) v-groove, Etch creates calming environments that foster productivity and well-being. Mix and match with Zintra Plain Panels to add design and pricing versatility for a cohesive and sophisticated look.

Available in 15 designs



Scan the QR code to find out more

Applications

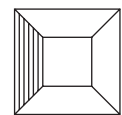

Walls





72. Product: Zintra Etch Panel Tessellate | Color: Spotted Gum



PANELS

Product: Zintra Etch Panel Spectrum | Color: Brick



Product: Zintra Etch Panel VJ Board Narrow  
Color: Spotted Gum | Project: @ladelizzia\_pizzeria  
Designer: @4Cadires | Photographer: @cafe.con.lily



Product: Zintra Etch Panel Cubix | Color: Pebble



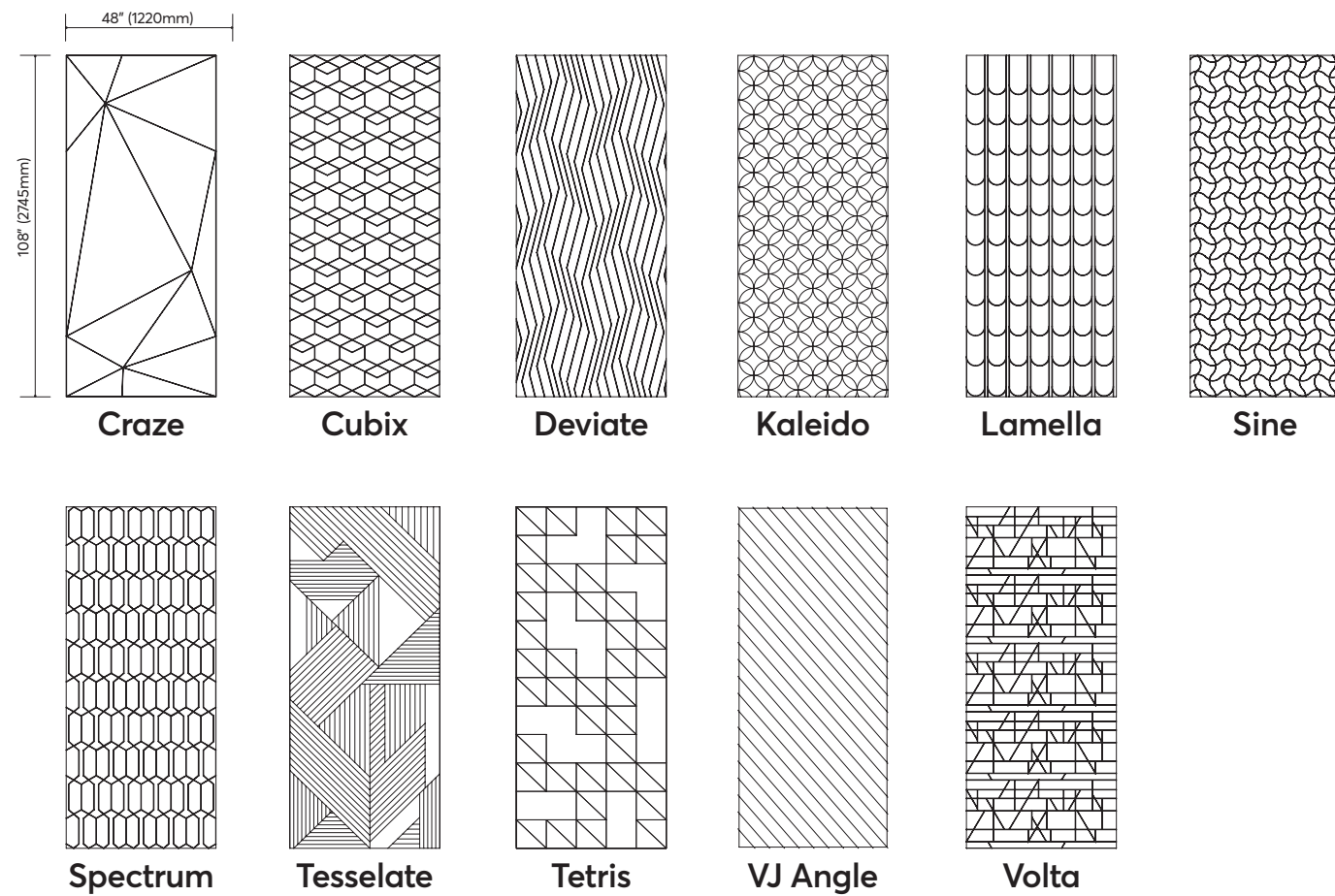

### Reed Bed

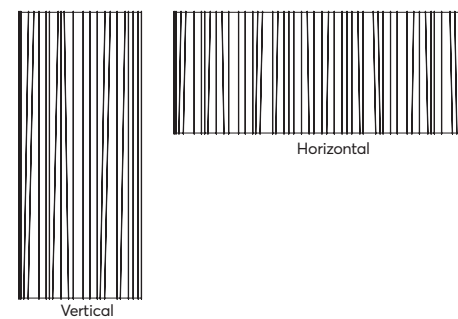

### Vino

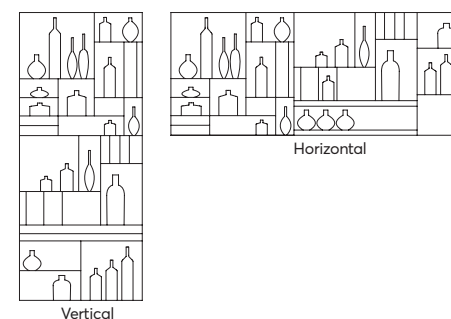

### V-Groove detail view

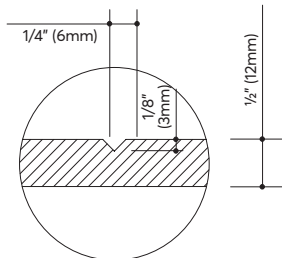

### VJ Board Narrow

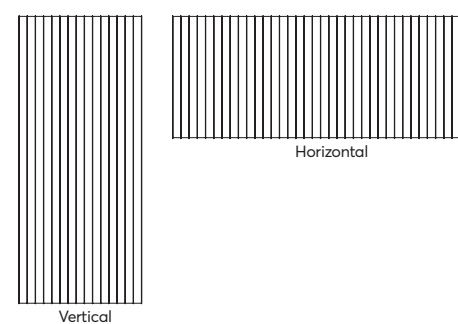

### VJ Board Wide

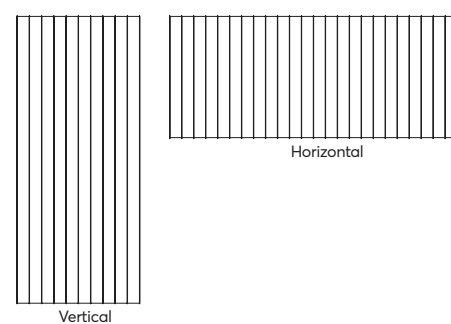

Product: Zintra Etch Panel VJ Angle | Color: Smoke | Project: Harbourfront Seafood Restaurant | Designer: Birdblack Design | Photographer: Andrew Ratter Photography

### Etch Panel Specifications

Dimensions	48" (1219mm) x 108" (2743mm) x 1/2" (12mm)			
Colors	Available in all 64 Colors, including Zintra Timber and Premium Prints. See p.11, p.12 and p.13			
NRC Rating	Directly Mounted: 0.45	With 2" (50mm) Air Gap: 0.85	With 6" (152mm) Air Gap: 0.90	With 12" (305mm) Air Gap: 0.95
Aw Rating	Directly Mounted: 0.30	With 2" (50mm) Air Gap: 0.75	With 6" (152mm) Air Gap: 0.95	With 12" (305mm) Air Gap: 0.95
Suggested Installation	Adhere to substrate using contact adhesive or Liquid Nails. Panel can be mechanically fixed using details similar to glass fittings. Check out the Technical Documents on our website to download the Installation Guide for more details.			
Additional Comments	Etch is a 1/8" (3mm) deep V groove. Not suitable as a free standing product.			
Customization	The Zintra Acoustic Solutions range is customizable to your project. Please get in touch with your local contact for details.			

## Organic Etch Panel

Zintra Organic Etch draws inspiration from artisan craftsmanship, seamlessly merging human creativity with the beauty of the natural world. Organic Etch panels add visual depth to interior spaces.

Available in a diverse range of designs and colors, each panel tells a story of simplicity, tactility, and imperfect perfection. Mix and match with Zintra Plain Panels to add design and pricing versatility for a cohesive and sophisticated look.

Available in 12 designs



Scan the QR code to find out more

Applications

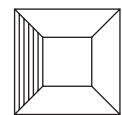

Walls

78.



Product: Zintra Organic Etch Panel  
Stream Horizontal | Color: Midnight

ZINTRA 79.



80. Product: Zintra Organic Etch Panel Rivers Vertical | Color: Cobalt



Product: Zintra Organic Etch Panel Ceramic | Color: Cadet

ZINTRA 81.



Product: Zintra Organic Etch Panel Plaid | Color: Smoke

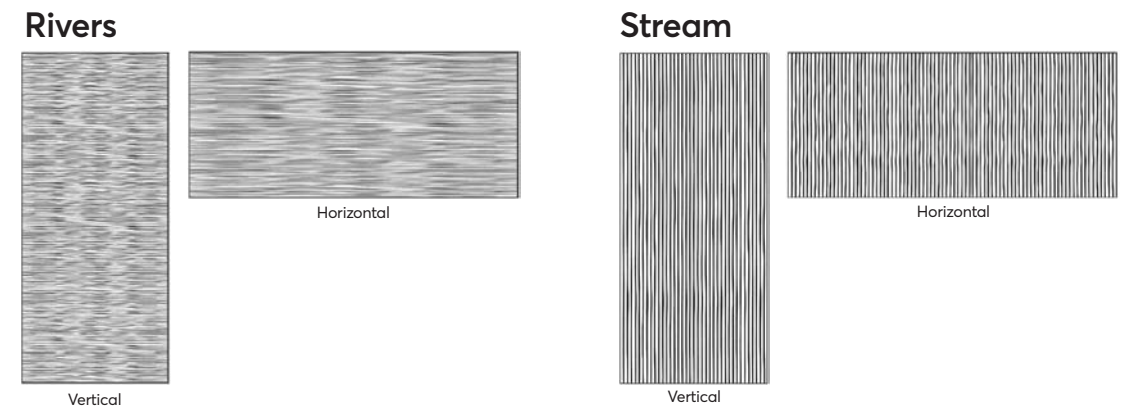
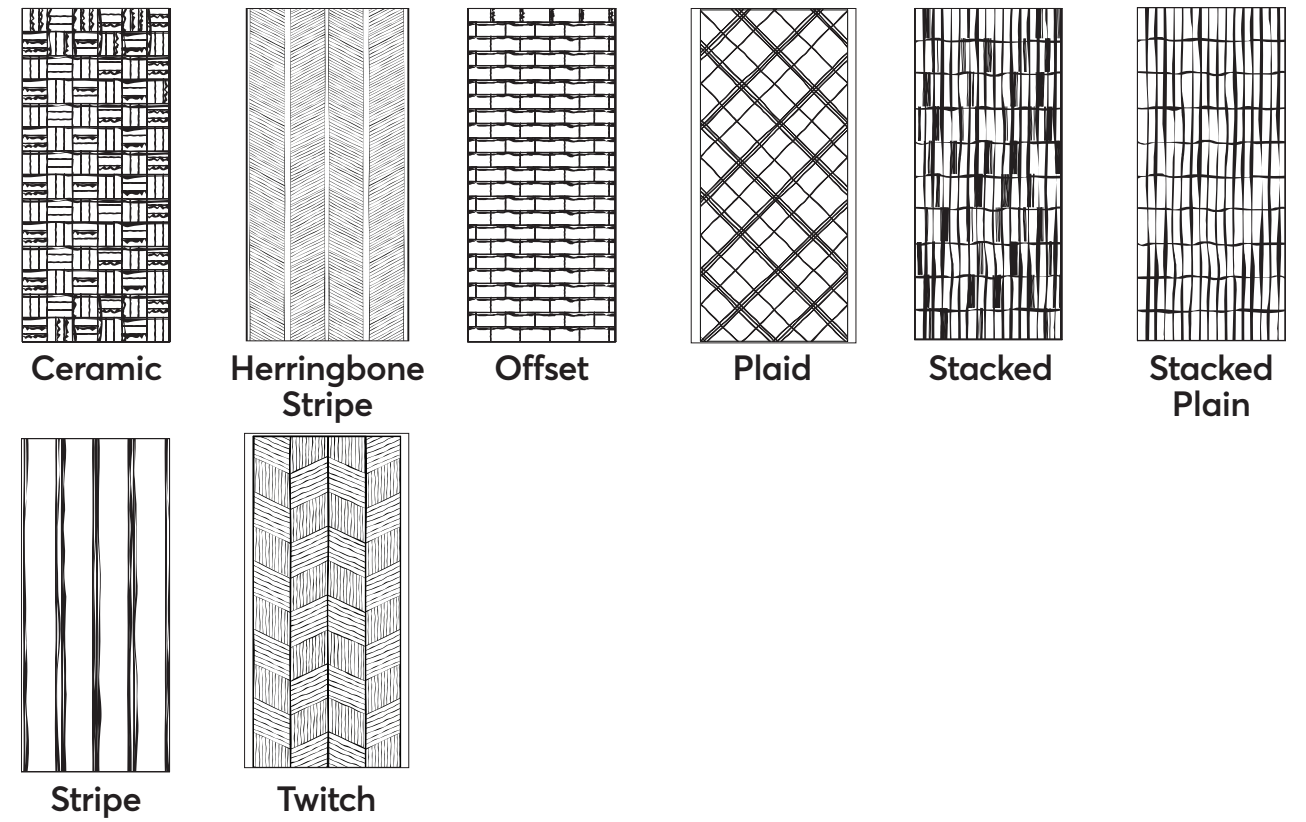

### Organic Etch Panel Specifications

Dimensions	48" (1219) mm x 108" (2743mm ) x 1/2" (12mm)			
Colors	Available in all 64 Colors, including Zintra Timber and Premium Prints. See p.11, p.12 and p.13			
NRC Rating	Directly Mounted: 0.45	With 2" (50mm) Air Gap: 0.85	With 6" (152mm) Air Gap: 0.90	With 12" (305mm) Air Gap: 0.95
Aw Rating	Directly Mounted: 0.30	With 2" (50mm) Air Gap 0.75	With 6" (152mm) Air Gap: 0.95	With 12" (305mm) Air Gap: 0.95
Suggested Installation	Adhere to substrate using contact adhesive or Liquid Nails. Panel can be mechanically fixed using details similar to glass fittings. Check out the Technical Documents on our website to download the Installation Guide for more details.			
Additional Comments	Not suitable as a free standing product. Organic Etch is imperfectly perfect and therefore while they are designed to be installed side by side, they are not seamlessly matched.			
Customization	The Zintra Acoustic Solutions range is customizable to your project. Please get in touch with your local contact for details.			

## Texture Panel

Zintra Texture offers subtle yet engaging 3-dimensional panel designs, each engineered to reduce echoes by altering sound reflection angles, making them perfect for noisy public spaces requiring a touch of flair.

Texture panels highlight the exceptional acoustic qualities of Zintra Acoustic Panels and showcase Zintra's impressive fabrication capabilities. With versatile designs, Texture will seamlessly integrate into both classic and modern settings. Mix and match with Zintra Plain Panels to add design and pricing versatility for a cohesive and sophisticated look.

Available in 15 designs



Scan the QR code to find out more

Applications

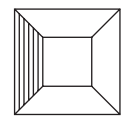

Walls





Product: Zintra Texture  
Panel Vague | Color: Linen

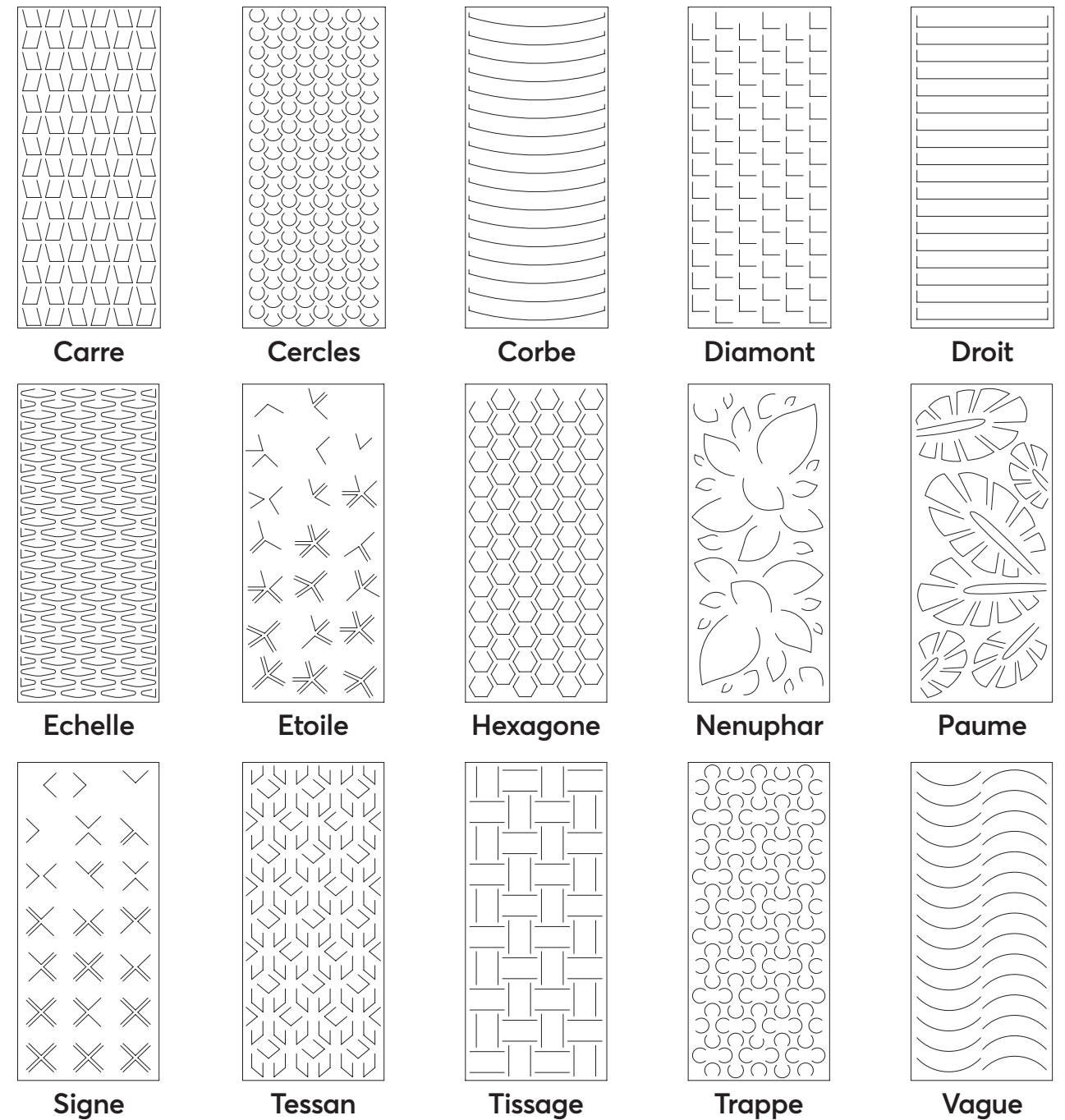

### Texture Panel Specifications

Dimensions	48" (1219mm) x 108" (2743mm) x 1/2" (12mm) (1" depth once textures push out)			
Colors	Available in all 64 Colors, including Zintra Timber and Premium Prints. See p.11, p.12 and p.13			
NRC Rating	Directly Mounted: 0.45	With 2" (50mm) Air Gap: 0.85	With 6" (152mm) Air Gap: 0.90	With 12" (305mm) Air Gap: 0.95
Aw Rating	Directly Mounted: 0.30	With 2" (50mm) Air Gap: 0.75	With 6" (152mm) Air Gap: 0.95	With 12" (305mm) Air Gap: 0.95
Suggested Installation	Adhere to substrate using contact adhesive. Panel can be mechanically fixed using details similar to glass fittings. Check out the Technical Documents on our website to download the Installation Guide for more details.			
Additional Comments	Not suitable as a free standing product. If additional thickness is desired the option to mount to a 1/2" MDF backer or 1/2" Sheet of Zintra for an overall 1" panel thickness is available.			

## Sculpted Panel

Zintra Sculpted Panels use shape and space to offer eye-catching interior design additions.

The signature 3/8" (9mm) groove detail adds depth and dimension, setting them apart as a sophisticated choice for feature walls or an eye-catching alternative to traditional art. Unlike the finer 1/8" (3mm) groove of Etch, Sculpted Panels command attention with their bold, progressive aesthetic, creating a visual statement that resonates with modern design sensibilities.

Available in 7 designs



Scan the QR code to find out more

Applications

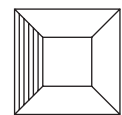

Walls





Product: Zintra Sculpted Panel Heli | Color: Pewter



Product: Zintra Sculpted Panel Cosmic | Color: Ecru

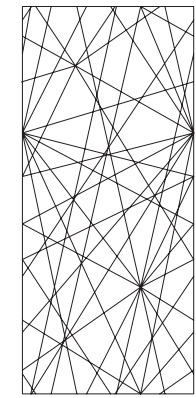

Cosmic

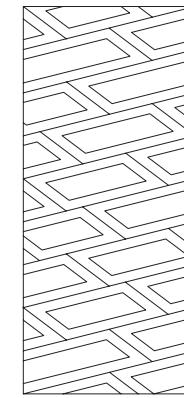

Cubic

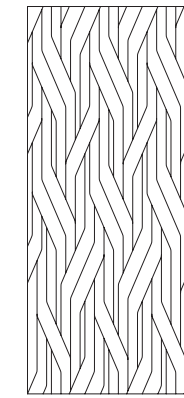

Heli

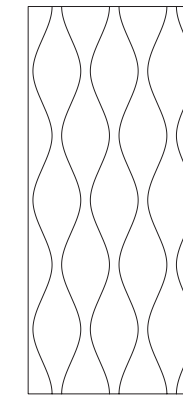

Hourglass

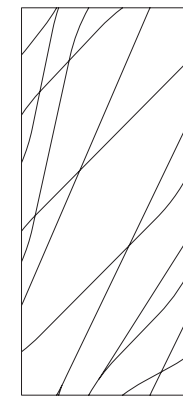

Scribe

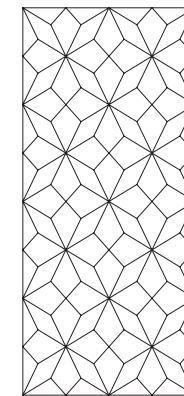

Starburst

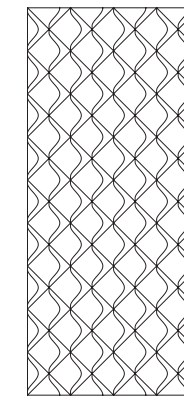

Stencil

V-Groove  
Detail View

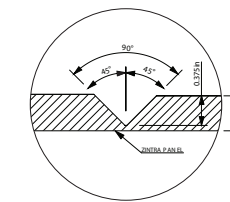

**Sculpted Specifications**

Dimensions:	47.5" (1206mm) x 108" (2743mm) x 1/2" (12mm)		
Colors	Available in all 64 Colors, including Zintra Timber and Premium Prints. See p.11, p.12 and p.13		
NRC Rating	Directly Mounted: 0.45	With 2" (50mm) Air Gap: 0.85	With 6" (152mm) Air Gap: 0.90
Aw Rating	Directly Mounted: 0.30	With 2" (50mm) Air Gap: 0.75	With 6" (152mm) Air Gap: 0.95
Suggested Installation	Adhere to substrate using contact adhesive, Liquid Nails. Check out the Technical Documents on our website to download the Installation Guide for more details		
Additional Comments	Sculpted is a 0.375" (9mm) deep V groove. Not suitable as a free standing product.		
Customization	The Zintra Acoustic Solutions range is customizable for your project. Please get in touch with your local contact for details.		



# Ceiling Features

Zintra Ceiling Features introduce a softness and sculptural allure to the practical acoustics of ceiling design. From striking geometric shapes to elegant floating elements, these Ceiling Features are ideal for creating standout focal points or adding a subtle touch, all while camouflaging unsightly fixtures and managing noise.



CEILING FEATURES

## Clouds

Crafted from pressure-fitted interlocking profiles, Zintra Clouds are available in an array of shapes and sizes for easy assembly and installation.

Clouds not only add dramatic flair to any space, but they also enhance acoustics through Zintra's powerful sound absorption qualities.

Available in 13 designs



Scan the QR code to find out more

Applications

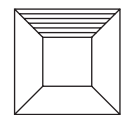

Ceilings



Product: Zintra Clouds  
Long Dome Concave  
Color: Midnight

ZINTRA 95.



96. Product: Zintra Clouds Blanchard | Color: Pewter, Mandarin & Sunshine



Product: Zintra Clouds Giffard | Color: Olive & Pewter

ZINTRA 97.

### Blanchard

27.3" (694mm) dia x 23.5" (595mm) h  
56.4" (1432mm) dia x 47" (1195mm) h

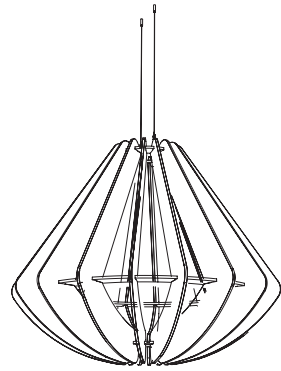

### Giffard

14.5" (364mm) dia x 23.5" (595mm) h  
27.3" (692mm) dia x 47" (1195mm) h  
45.6" (1160mm) dia x 71" (1802mm) h

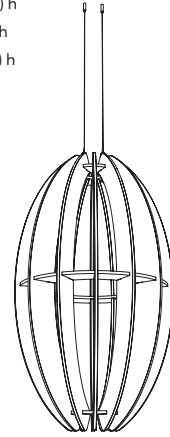

### Turbine

50" (1270mm) w x 50" (1270mm) d x 15.75" (400mm) h

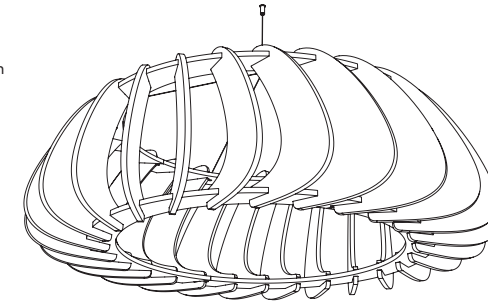

### Clochette

39" (992mm) w x 44.1" (1121mm) l x 9.2" (232mm) h

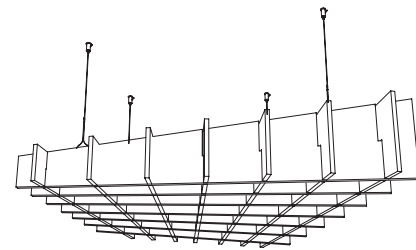

### Square

48" (1220mm) w x 48" (1220mm) l x 6" (150mm) h  
48" (1220mm) w x 108" (2745mm) l x 6" (150mm) h  
108" (2745mm) w x 108" (2745mm) l x 6" (150mm) h  
108" (2745mm) w x 108" (2745mm) l x 9" (225mm) h

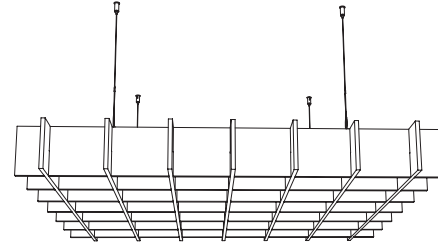

### Long Dome Convex

42.4" (1077mm) w x 97.5" (2476mm) d x 11.8" (300mm) h

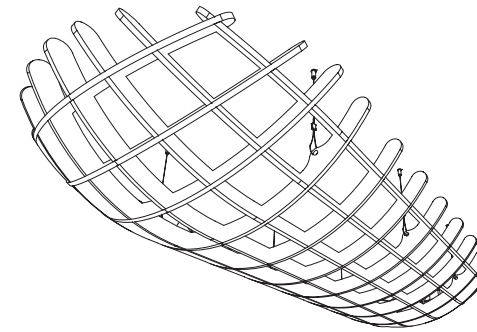

### Long Dome Concave

42.4" (1077mm) w x 97.5" (2476mm) d x 11.8" (300mm) h

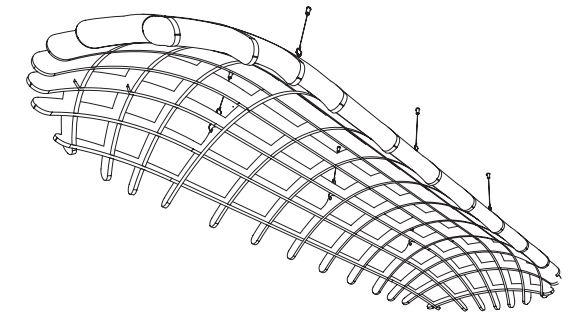

### Drante

48" (1220mm) w x 48" (1220mm) l x 5.5" (140mm) h  
72" (1832mm) w x 72" (1832mm) l x 9" (229mm) h

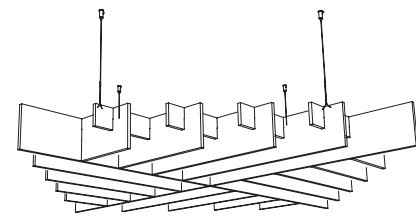

### Yoofoe

48" (1220mm) dia x 6.2" (156mm) h  
72" (1829mm) dia x 8" (204mm) h  
96" (2438mm) dia x 10" (254mm) h  
108" (2745mm) dia x 10" (254mm) h

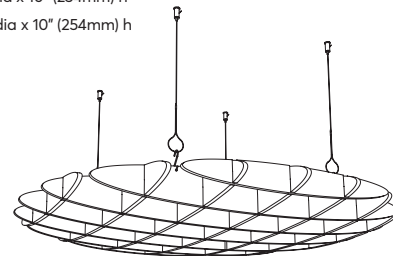

### Dome Convex

44.6" (1133mm) w x 44.6" (1133mm) d x 11.8" (300mm) h

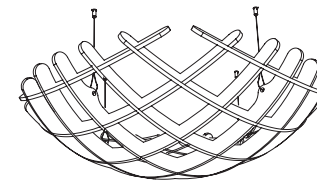

### Dome Concave

44.6" (1133mm) w x 44.6" (1133mm) d x 11.8" (300mm) h

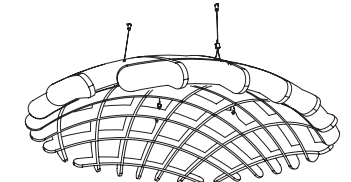

### Warp

48" (1220mm) w x 48" (1220mm) l x 5.5" (140mm) h  
108" (2745mm) w x 108" (2745mm) l x 9" (229mm) h

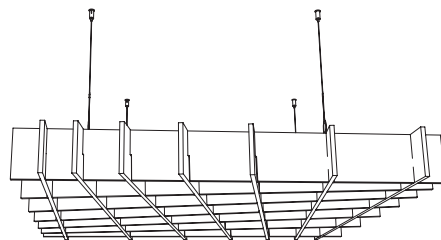

### Stratus

28" (711mm) w x 55" (1398mm) l x 11.5" (290mm) h

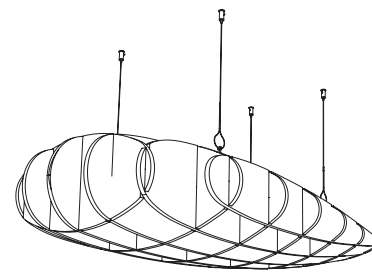

### Clouds Specifications

Dimensions	See spread.	
Colors	Available in all 64 Colors, including Zintra Timber and Premium Prints. See p.11, p.12 and p.13	
NRC Rating	Without Air Gap: 0.90	With 24" (610mm) Air Gap: up to 1.00
Aw Rating	Without Air Gap: 0.80	With 24" (610mm) Air Gap: up to 1.00
Suggested Installation	Cloud components supplied flat pack. Assembled cloud is then suspended from the ceiling using hanging hardware supplied. Check out the Technical Documents on our website to download the Installation Guide for more details.	
Additional Comments	Only available from Zintra Acoustic Panel 1/2" (12mm). Clouds include Adjustable Suspension Kit (ASK). See p.200 for hardware detail. Longer Cables, multi-color and Digital Print available for an additional fee.	

## Shapes

Zintra Shapes utilizes geometric forms to complement the traditional angles of a room.

Effective individually or as an ensemble, these shapes can be strategically hung to highlight a particular area or distributed to guide the eye across the span of a room.



CEILING FEATURES

Available in 7 designs



Scan the QR code to find out more

Applications

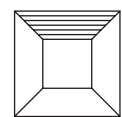

Ceilings



Product: Zintra Shapes (Custom) Emboss Jungle (custom)  
 Color: Linen | Project: Panorama Cellars Tasting Counter  
 Specifier/Installer: Surround Interiors

### Triangle

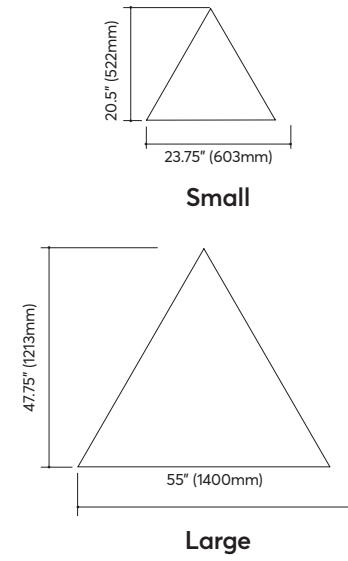

### Circle

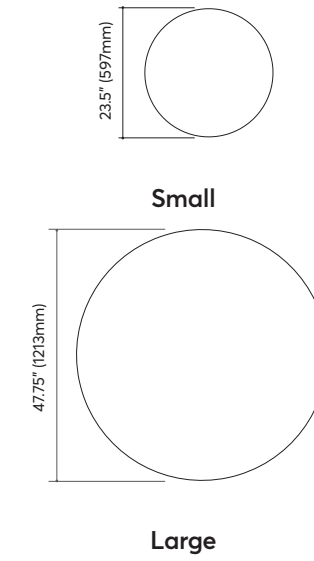

### Hexagon

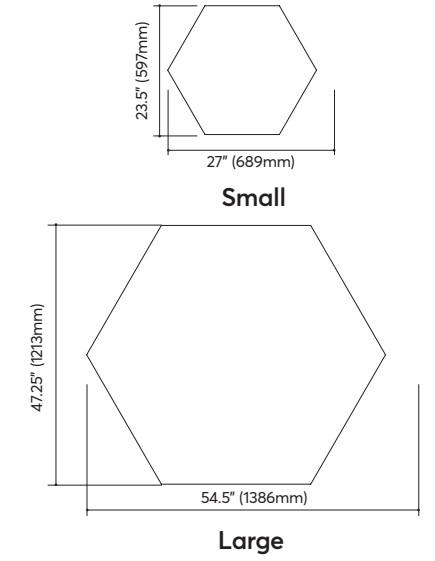

### Square

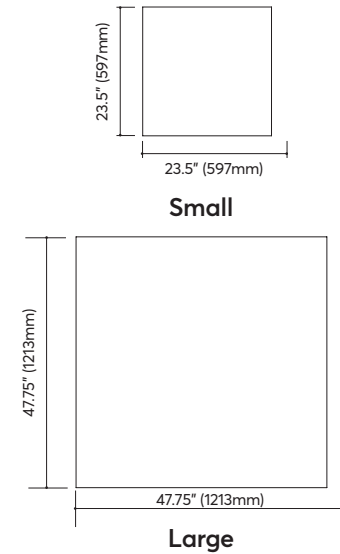

### Rectangle

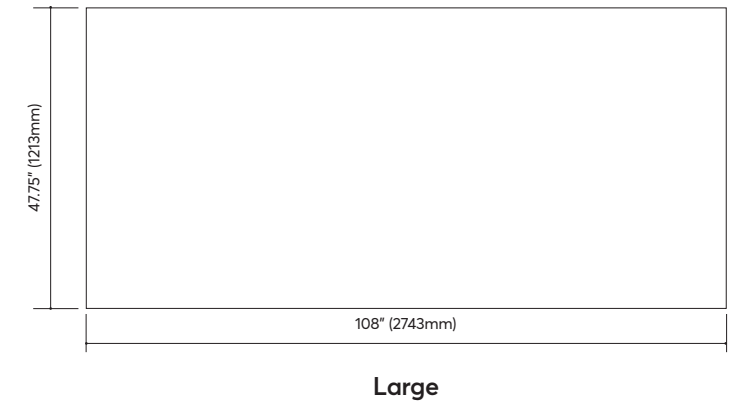

CEILING FEATURES

### Shapes Specifications

Dimensions	See above.			
Colors	Available in all 64 Colors, including Zintra Timber and Premium Prints. See p.11, p.12 and p.13			
1/2" (12mm) NRC Rating	Directly Mounted: 0.45	With 2" (50mm) Air Gap: 0.85	With 6" (152mm) Air Gap: 0.90	With 12" (305mm) Air Gap: 0.95
Aw Rating	Directly Mounted: 0.30	With 2" (50mm) Air Gap: 0.75	With 6" (152mm) Air Gap: 0.95	With 12" (305mm) Air Gap: 0.95
Suggested Installation	Hang with supplied cables. Check out the Technical Documents on our website to download the Installation Guide for more details.			
Additional Comments	Available in 1/2" (12mm) thickness			
Customization	The Zintra Acoustic Solutions range is customizable to your project. Please get in touch with your local contact for details.			

# Emboss Ceiling Tiles

Emboss Ceiling Tiles instantly elevate spaces with progressively matched patterns across sheets, creating a seamless, layered effect.

Designed to fit standard 2x2 ceiling grids, Emboss Ceilings enhance acoustics and refresh spaces effortlessly.

Product: Zintra Emboss Ceiling Tiles | Color: Malachite | Pattern: Jungle

Available in 13 designs

Applications



Scan the QR code to find out more

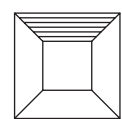

Ceilings



CEILING FEATURES

### Constellation

23.62" (600mm) w x 24" 23.62" (600mm) h

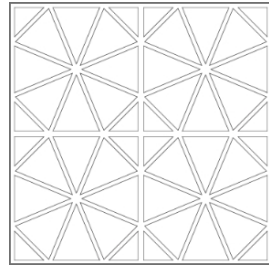

### Corduroy

23.62" (600mm) w x 24" 23.62" (600mm) h

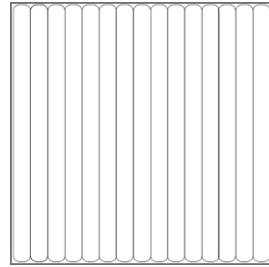

### Cumulus

23.62" (600mm) w x 24" 23.62" (600mm) h

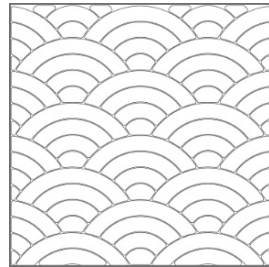

### Damask

23.62" (600mm) w x 24" 23.62" (600mm) h

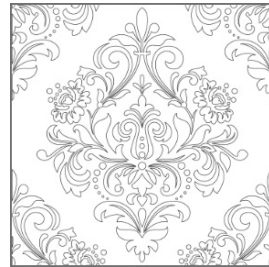

### Jungle

23.62" (600mm) w x 24" 23.62" (600mm) h

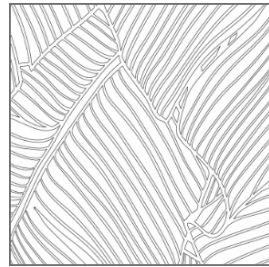

### Linked

23.62" (600mm) w x 24" 23.62" (600mm) h

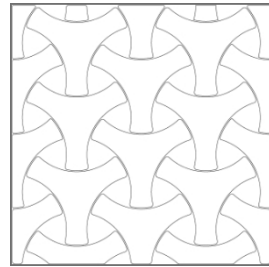

### Molecular

23.62" (600mm) w x 24" 23.62" (600mm) h

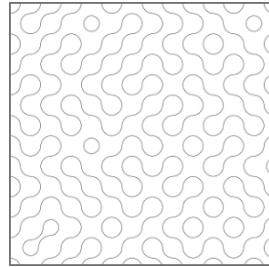

### Sandglass

23.62" (600mm) w x 24" 23.62" (600mm) h

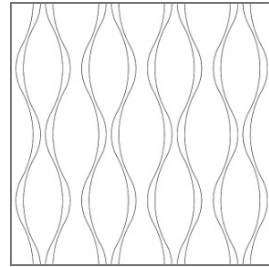

### Tapestry

23.62" (600mm) w x 24" 23.62" (600mm) h

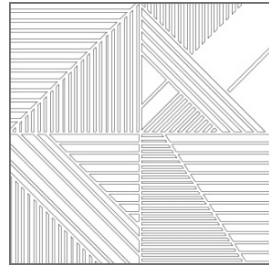

### Tidal

23.62" (600mm) w x 24" 23.62" (600mm) h

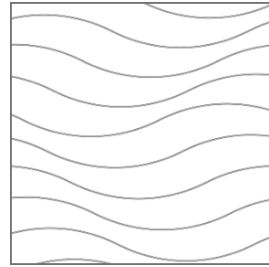

### Quick Ship Program

Quick Ship Emboss Ceiling Tiles are stocked in the frost color and ready to ship immediately in quantities of 16 tiles per pattern. For more color options, a minimum order of 80 tiles is required.

### Chev

24" (609.6mm) w x 24" (609.6mm) h



### Crossway

24" (609.6mm) w x 24" (609.6mm) h



### Cubi

24" (609.6mm) w x 24" (609.6mm) h



### Emboss Ceiling Tiles Specifications

Dimensions	See above.			
Colors	Available in all 64 Colors, including Zintra Timber and Premium Prints. See p.11, p.12 and p.13			
1/2" (12mm) NRC Rating	Directly Mounted: 0.45	With 2" (50mm) Air Gap: 0.85	With 6" (152mm) Air Gap: 0.90	With 12" (305mm) Air Gap: 0.95
Aw Rating	Directly Mounted: 0.30	With 2" (50mm) Air Gap: 0.75	With 6" (152mm) Air Gap: 0.95	With 12" (305mm) Air Gap: 0.95
Suggested Installation	Will work with 15/16" or 9/16" Suspended T-Grid system (T-Grid not supplied). Check out the Technical Documents on our website to download the Installation Guide for more details.			
Additional Comments	Available in 1/2" (12mm) thickness			
Customization	The Zintra Acoustic Solutions range is customizable to your project. Please get in touch with your local contact for details.			



# Baffles

Master the art of sound with Zintra Baffles. Absorbing sound from multiple directions, these Baffles blend impact with elegance. Whether enhancing a focal point or an entire ceiling, they deliver a visual and acoustic masterpiece. With various designs available and thoughtful assembly and installation, Baffles provide an efficient and adaptable solution for improving acoustics to suit any space's needs.

DCXC  
Technology Center

## Baffle Systems

Zintra Baffle Systems masterfully absorb sound from multiple directions, combining modern aesthetics with decorative elements and a broad spectrum of colors and patterns.

Providing an innovative alternative to traditional mineral fiber lay-in systems, Baffle Systems offer the flexibility to be individually configured as a standout feature or installed to enhance the entire ceiling's visual charm. With refined assembly and installation, Baffle Systems provide an efficient and adaptable solution for improving acoustics to meet any space's demands. By diminishing noise levels and boosting speech clarity, our sound baffles facilitate a calm and appealing environment.

Available in 11 designs



Scan the QR code to find out more

Applications

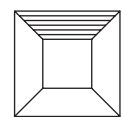

Ceilings





Product: Zintra Baffle System Custom Wave | Color: Ecrú with Satin Black Powder Coat | Project: Rydges Coolangatta  
Designer: Design Nu | Photographer: AH Photography



Product: Zintra Baffle System Custom | Color: Frost  
Project: Rydges Coolangatta | Designer: Design Nu  
Photographer: AH Photography

### Small Baffle

Available in 4.7" (120mm) or 9.5" (240mm) deep

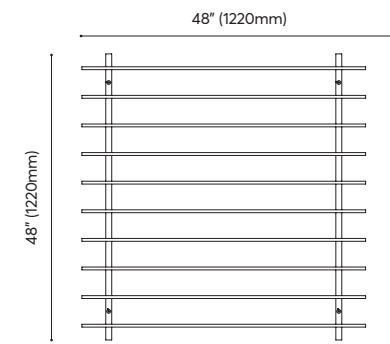

### Large Baffle

Available in 4.7" (120mm) or 9.5" (240mm) deep

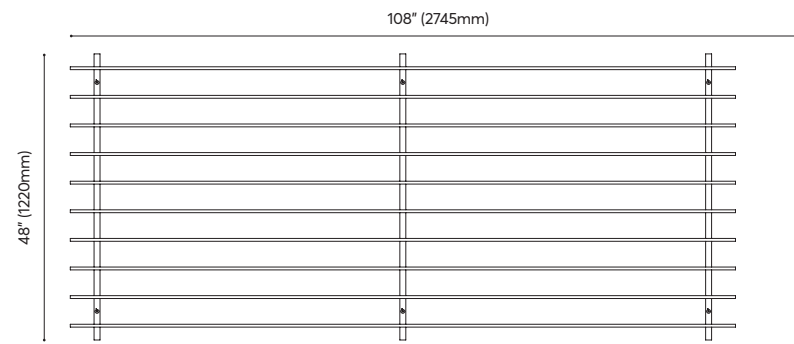

### Square\*

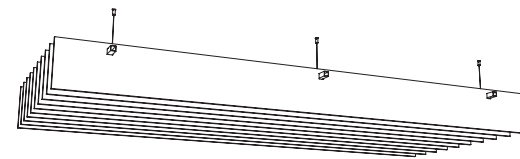
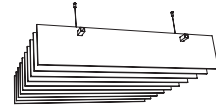

### Bolt

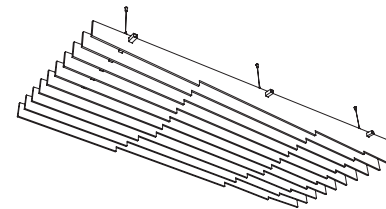
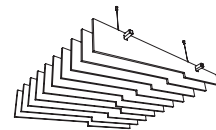

### Canyons

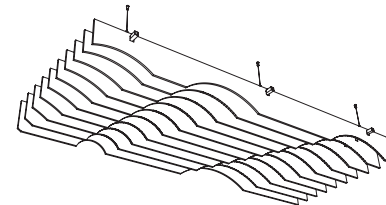
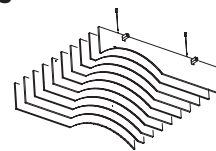

### Ridges

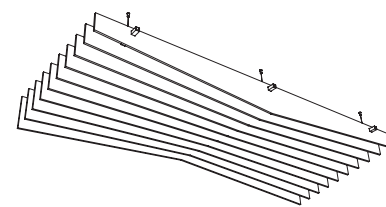
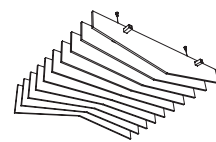

### Swell

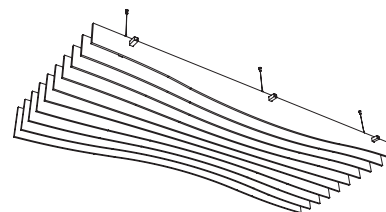
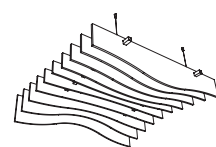

### Gorge\*\*

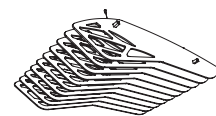

\*Available with 4.8" spacing (10 Baffles), 8" spacing (6 Baffles), 12" spacing (4 Baffles)  
 \*\*Also available in 48" (1220mm) w x 72" (1829mm) l x 16.8" (428mm) h

### Waves

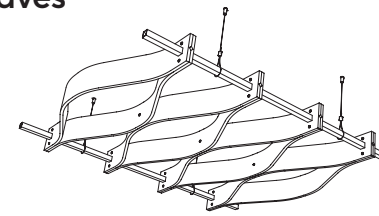

48" (1220mm) w x 54" (1373mm) d x 4.7" (120mm) h

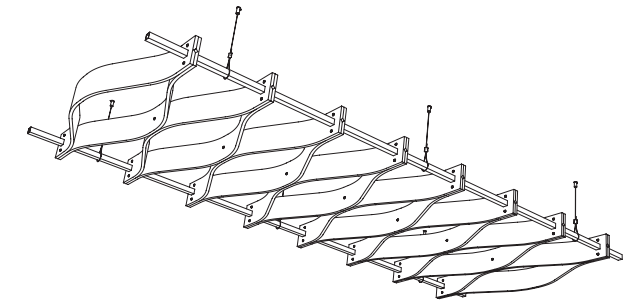

48" (1220mm) w x 108" (2745mm) d x 4.7" (120mm) h

### V-Fold

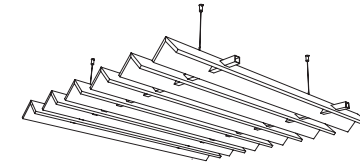

48" (1220mm) w x 48" (1220mm) d x 3.1" (80mm) h

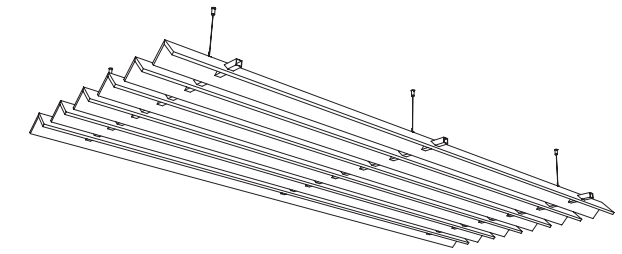

48" (1220mm) w x 108" (2745mm) d x 3.1" (80mm) h

### Louvre

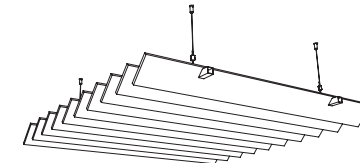

48" (1220mm) w x 48" (1220mm) d x 3.7" (94mm) h

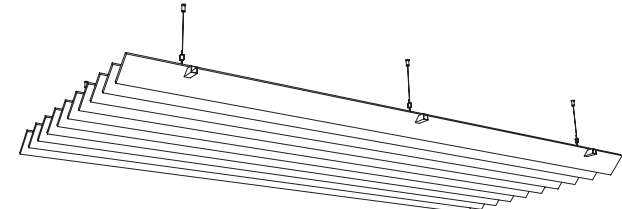

48" (1220mm) w x 108" (2745mm) d x 3.7" (94mm) h

### Quarter Baffle Circle

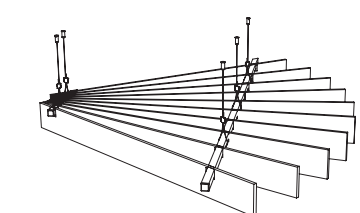

52" (1324mm) w x 72" (1827mm) d x 4.3" (110mm) h

### Baffle Circle

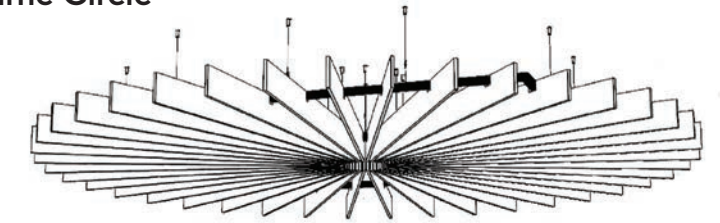

110" (2800mm) w x 110" (2800mm) d x 4.3" (110mm) h  
 Setup by connecting (4) Quarter Baffle Circle systems

### Baffle Systems Specifications

Dimensions	See spread.	
Colors	Available in all 64 Colors, including Zintra Timber and Premium Prints. See p.11, p.12 and p.13. See p.214 for Powder Coat Colors.	
NRC Rating	Without Air Gap: 0.90	With 24" (610mm) Air Gap: Up to 0.95
Aw Rating	Without Air Gap: 0.80	With 24" (610mm) Air Gap: Up to 0.80
Suggested Installation	Be sure to support Baffles during installation to avoid bowing or creasing. Slide Baffles onto notched Square Tube to position it in place. Fix Adjustable Cables to ceiling. Adjust cables to complete installation.	
Additional Comments	Only available from Zintra Acoustic Panel 1/2" (12mm) Baffles include Adjustable Suspension Kit (ASK) and Square Tube. See p.200 for hardware detail. Longer Cables, multi-color and Digital Print available for an additional fee.	
Customization	The Zintra Acoustic Solutions range is customizable to your project. Please get in touch with your local contact for details.	

## Box Baffles

Zintra Box Baffles are box-shaped baffles designed to hang from the ceiling in uniformly spaced rows. This prefabricated, ceiling-mounted system offers an innovative alternative to traditional mineral fiber lay-in systems.

The distinct box shape not only elevates the aesthetics but also optimizes acoustic performance by effectively trapping sound. With refined assembly and installation, Box Baffles provide an efficient and adaptable solution for improving acoustics to meet the demands of any space.

Available in 5 designs



Scan the QR code to find out more

Applications

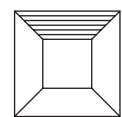

Ceilings





Product: Zintra Box Baffles Random  
Color: Pewter, Slate & Ivory

### Random\*

Isometric

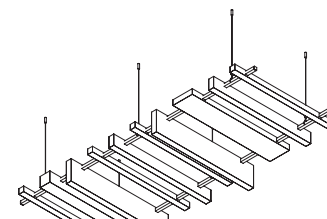

Top

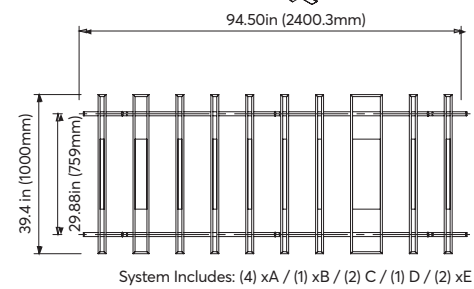

### Mixed\*

Isometric

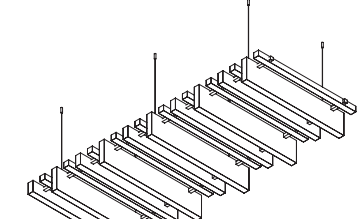

Top

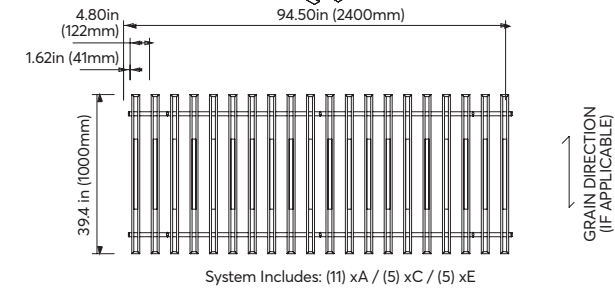

### Uniformed Low\*

Isometric

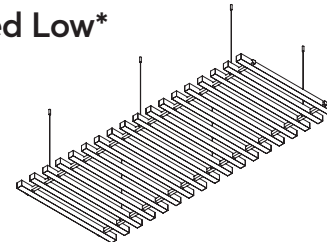

Top

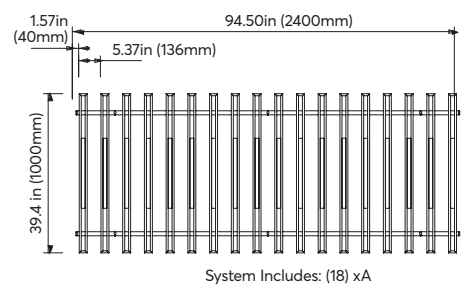

### Uniformed High\*

Isometric

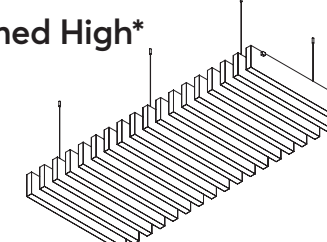

Top

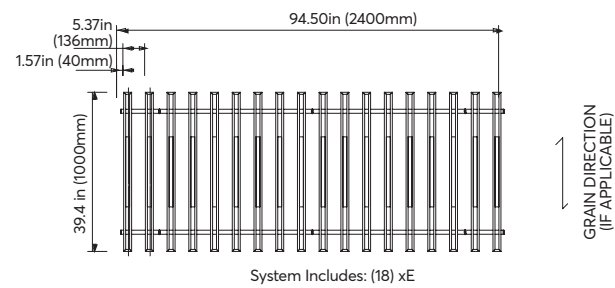

\* Also available in 93" (2362mm) x 94.5" (2400mm) Systems

### Individual Box Baffle Profiles

\*Hang as part of a system or can hang as individual box baffles

#### Box Baffle A

2" w x 39.4" l x 2" h  
2" w x 93" l x 2" h

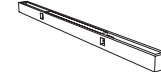

#### Box Baffle B

8" w x 39.4" l x 2" h  
8" w x 93" l x 2" h

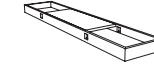

#### Box Baffle C

2" w x 39.4" l x 4" h  
2" w x 93" l x 4" h



#### Box Baffle D

4" w x 39.4" l x 4" h  
4" w x 93" l x 4" h

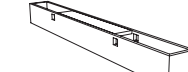

#### Box Baffle E

2" w x 39.4" l x 8" h  
2" w x 93" l x 8" h



### Box Baffles Specifications

Dimensions	See above.	
Colors	Available in all 64 Colors, including Zintra Timber and Premium Prints. See p.11, p.12 and p.13. See p.214 for Powder Coat Colors.	
NRC Rating	Without Air Gap: 0.90	With 24" (610mm) Air Gap: Up to 0.95
Aw Rating	Without Air Gap: 0.80	With 24" (610mm) Air Gap: Up to 0.80
Suggested Installation	Be sure to support Baffles during installation to avoid bowing or creasing. Slide Baffles onto notched Square Tube to position it in place. Fix Adjustable Cables to ceiling. Adjust cables to complete installation. Check out the Technical Documents on our website to download the Installation Guide for more details.	
Additional Comments	Only available from Zintra Acoustic Panel 1/2" (12mm). Baffles include Adjustable Suspension Kit (ASK) and Square Tube. See p. 200 for hardware detail. Longer Cables, multi-color and Digital Print available for an additional fee.	
Customization	The Zintra Acoustic Solutions range is customizable to your project. Please get in touch with your local contact for details.	

## Mesh Baffles

Zintra Mesh Baffles offer a stylish and functional acoustic ceiling solution that can serve as dynamic focal points or wall-to-wall applications.

Scalable and cost-effective, sets of Mesh Baffles integrate seamlessly with each other using a unique interconnecting system and are suspended by Y-Hook cables for easy installation.

Available in 6 designs



Scan the QR code to find out more

Applications

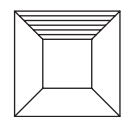

Ceilings

120.



BAFFLES

Product: Zintra Mesh Baffles Checkered | Color: Ivory & Greige  
Powder Coat Color: Anodized Silver

ZINTRA 121.



Product: Zintra Mesh Baffles | Color: Premium Wood White Oak, Saffron, Elderberry, Storm, Twilight, Meadow, Parchment | Powder Coat Color: Matte Black



Product: Zintra Mesh Baffles | Color: Midnight  
Powder Coat Color: Spice | MDC Interior Solutions





Product: Zintra Mesh Baffles Offset | Color: Cadet  
124. Powder Coat Color: Bengal White



Product: Zintra Mesh Baffles  
 Long Offset | Color: Premium  
 Wood Rustic Walnut  
 Powder Coat Color: Spice

### Herringbone

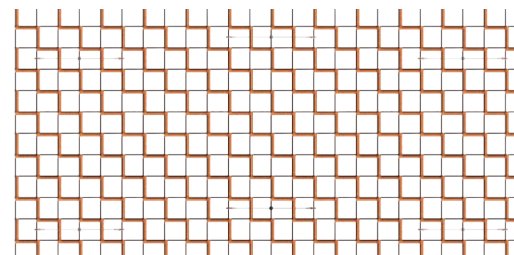

### Random

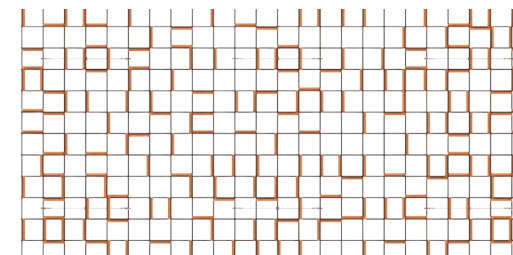

### Short Offset

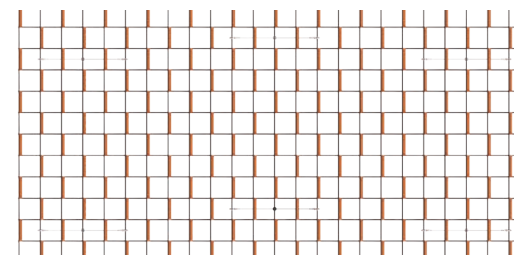

### Long Offset

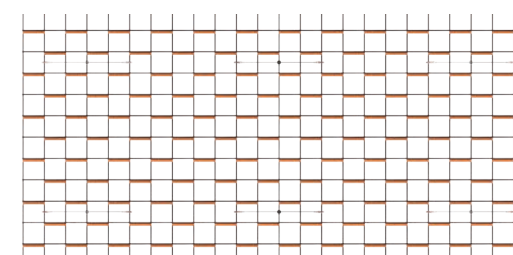

### Offset

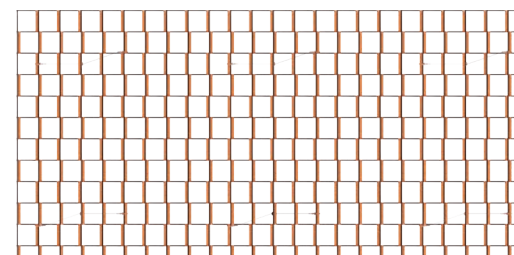

### Checked

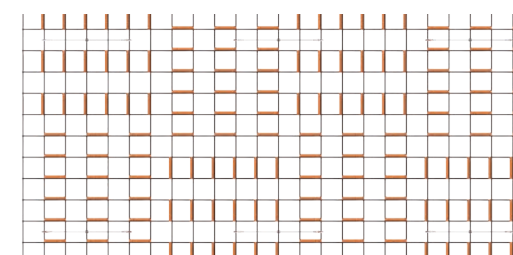

### Mesh Baffles Specifications

Dimensions	48" (1219mm) w x 96" (2400mm) l x 8.2" (209mm) h   Individual Quill 4" (106mm) x 8.2" (209mm) x 1/2" (12mm)
Colors	Available in all 64 Colors, including Zintra Timber and Premium Prints. See p.11, p.12 and p.13. See p.214 for Powder Coat Colors.
NRC Rating	Up to 1.0
Aw Rating	Up to 0.95
Suggested Installation	Assemble your Mesh Baffle System then suspend from the ceiling using the hanging hardware supplied. Check out the Technical Documents on our website to download the Installation Guide for more details.
Additional Comments	Digital Print available for an additional fee.
Customization	The Zintra Acoustic Solutions range is customizable to your project. Please get in touch with your local contact for details.

## Beams

Zintra Beams, with their sense of structure and architectural grandeur, are perfect for large spaces.

Engineered for superior sound absorption, with an NRC of up to 1.5, Zintra Beams function as porous absorbers across the entire frequency range, significantly enhancing the overall NRC rating of a space. Their modular design allows for a variety of configurations across a range of styles and sizes and includes connectors and coffers for effortless customization to suit any space.

Available in 5 designs



Scan the QR code to find out more

Applications

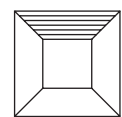

Ceilings

128.



BAFFLES

Product: Zintra Beams Square  
Color: Premium Wood Rustic Walnut

ZINTRA 129.



Product: Zintra Beams Closed Rafter  
Color: Linen



Product: Zintra Beams Parallel Beam  
Color: Premium Wood White Oak

### Open Rafter

Configurations 1 x 5, 2 x 5, 3 x 5, 4 x 5 and 5 x 5.  
Available with and without coffer.

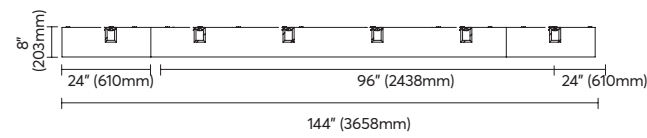
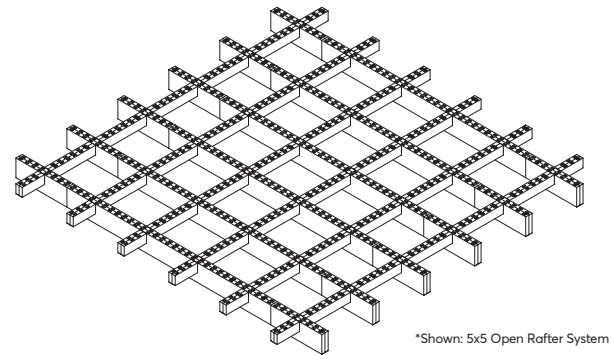

### Closed Rafter

Configurations 1 x 5, 2 x 5, 3 x 5, 4 x 5 and 5 x 5.  
Available with and without coffer.

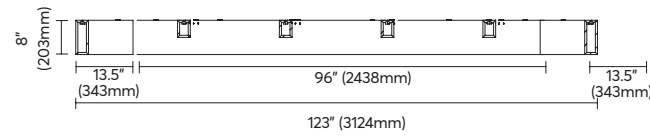
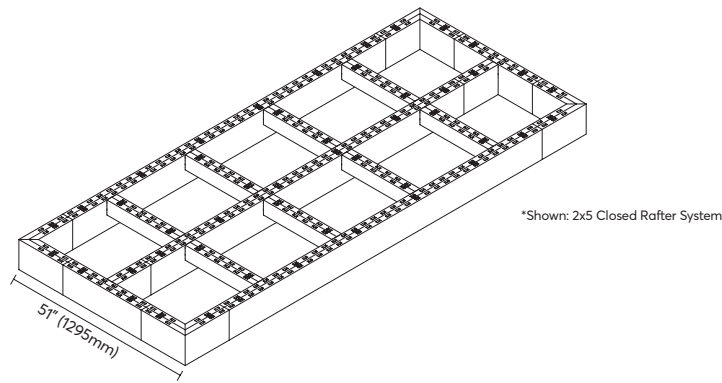

### Square Beam

Available with and without coffer.

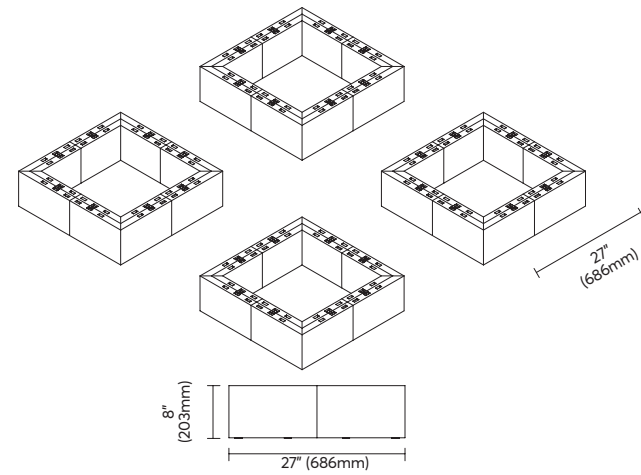

### Rectangle Beam

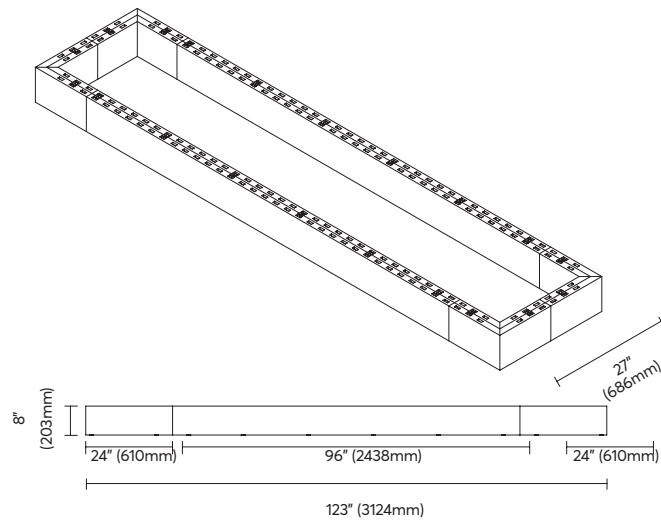

### Parallel Beam

Qty 8 per set

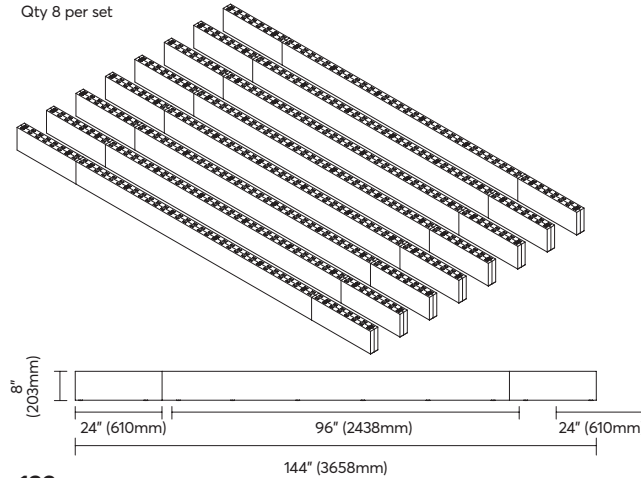

### Coffer

Compatible with Open Rafter, Closed Rafter, and Square Beams systems.

Qty 8 Coffers per set

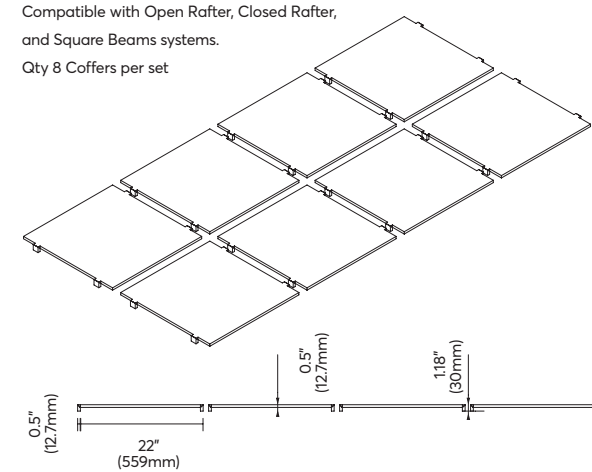

Product: Zintra Beams Closed Rafters with and without Coffers | Color: Premium Wood Palm Wood

BAFFLES

### Beams Specifications

Dimensions	See above.
Colors	Available in all 64 Colors, including Zintra Timber and Premium Prints. See p.11, p.12 and p.13
NRC Rating	Up to 1.5 with Coffers
Aw Rating	Up to 1.0 with Coffers
Suggested Installation	Ships Flat Pack. Assembly Required. Cable Suspension OR Unistrut. Refer preferred installation method Install Guide Go to the Technical Documents and download the Installation Guide for more details.
Additional Comments	Available in Premium Prints.
Customization	The Zintra Acoustic Solutions range is customizable to your project. Please get in touch with your local contact for details.

## Connect

Zintra Connect adds sculptural, on-trend geo-accents to your ceiling space. This innovative ceiling solution improves acoustics in large areas, creating a ceiling space with architectural shape, form, and definitive character.

Connect offers the flexibility to be individually configured as a standout feature or installed to enhance the entire ceiling's visual charm, all without the need for customized shop drawings.

Available in 5 designs



Scan the QR code to find out more

Applications

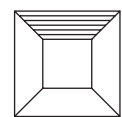

Ceilings





136. Product: Zintra Connect Prismatic | Color: Pebble



Product: Zintra Connect Hive | Color: Brick

## Connect Cirrus

141.5" (3595mm) x 89.6" (2275mm)

\*To account for angle of design use: 89.5" x 103"

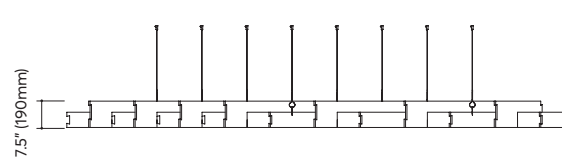
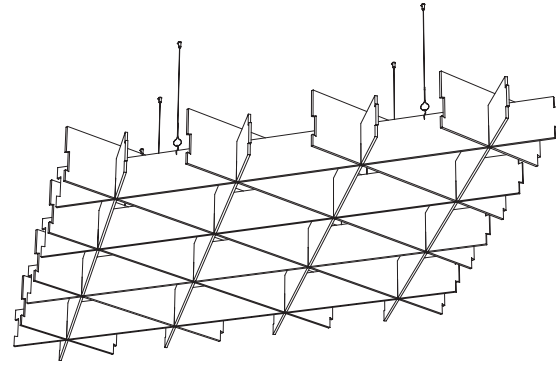

Cirrus Low

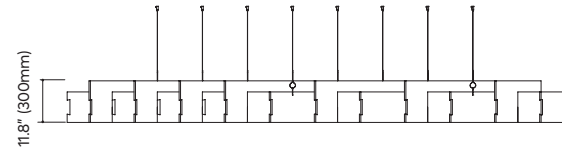

Cirrus High

## Connect Rise

48" (1220mm) x 109.8" (2790mm)

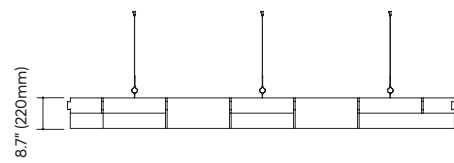
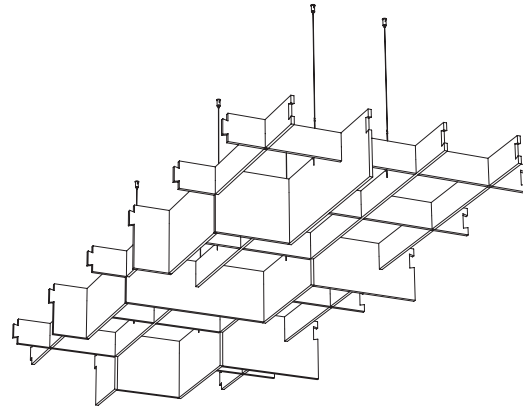

Rise Low

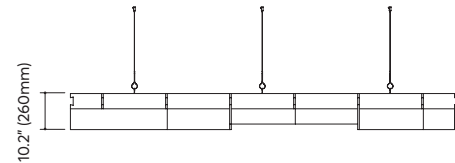

Rise High

## Connect Cubix

18 cubes / set, 18.9 SF (1.8m<sup>2</sup>)

System Dims: 36.6" (930mm) w x 74.4" (1889mm) d x 4.7" (120mm) h

Single Cube Dims: 11.5" x 11.5" x 4.7"

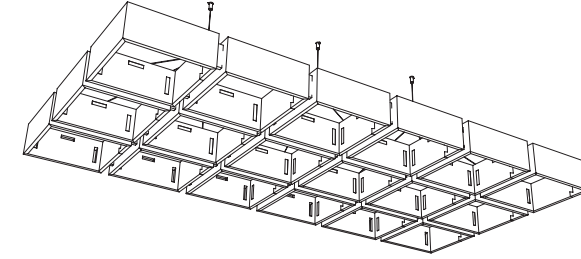

## Connect Hive

18 hexagons / set, 21.7 SF (2.6m<sup>2</sup>)

System Dims: 40.5" (1027mm) w x 100" (2544mm) d x 4.7" (120mm) h

Single Hexagon Dims: 13.3" x 15.3" x 4.7"

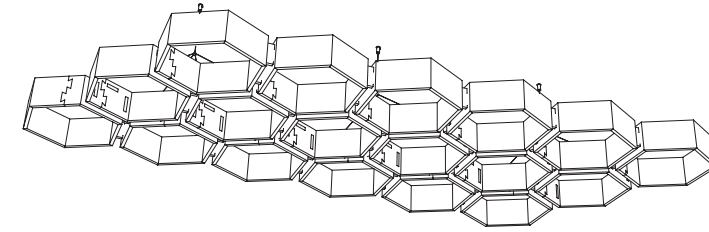

## Connect Prismatic

18 triangles / set, 16.9 SF (1.7m<sup>2</sup>)

System Dims: 30.2" (768mm) w x 88.2" (2241mm) d x 4.7" (120mm) h

Single Triangle Dims: 15.5" x 15.5" x 4.7"

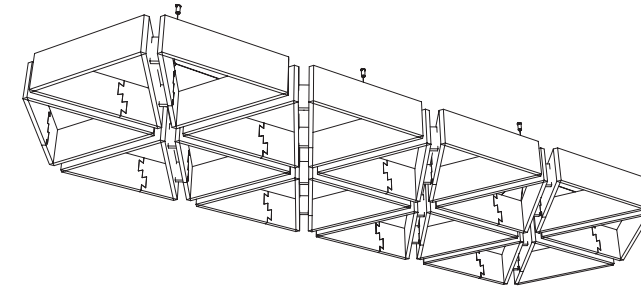

## Connect Specifications

Dimensions	See above.
Colors	Available in all 64 Colors, including Zintra Timber and Premium Prints. See <a href="#">p.11</a> , <a href="#">p.12</a> and <a href="#">p.13</a>
NRC Rating	0.90
Aw Rating	0.80
Suggested Installation	Connect components are supplied flat pack. Fix Adjustable Suspension Kit (ASK) or 4 way Adjustable Suspension Kit (Connect Cubix, Hive and Prismatic only) to ceiling. See <a href="#">p.200</a> for hardware detail. Check out the Technical Documents on our website to download the Installation Guide for more details.
Customization	The Zintra Acoustic Solutions range is customizable to your project. Please get in touch with your local contact for details.



# Acoustic Sticks

Zintra Sticks offer creative freedom and functionality in a lightweight, versatile, and easy-to-fabricate format. Perfect for feature walls, curved walls, space division, and even seamless progression from wall to ceiling, Sticks provide a vast range of possibilities to transform any area into an extraordinary, acoustically optimized environment.

ACOUSTIC STICKS

## Sticks Bundles

Available as a complete system, Zintra Sticks Bundles' unique design ensures effective sound absorption while adding a modern, dynamic element to your space.

Zintra Sticks are available in two profiles that can be mounted on walls or ceilings in either landscape or portrait orientation. Add on the purpose-designed Sticks Transition to ensure seamless integration at corners from walls to ceilings, and use Sticks Trim to provide a neat finish around doors, windows, and GPOs.

Available in 2 widths



Scan the QR code to find out more

Applications

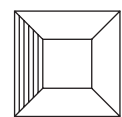

Walls

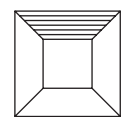

Ceilings





Product: Zintra Sticks Bundle Narrow Custom Column  
Orientation: Portrait | Color: Merbau  
144.



Product: Zintra Sticks Wide | Color: Spotted Gum  
Project: Elgin Country Club | Designer: MDC Interior Solutions

ACOUSTIC STICKS

## Sticks Corner

Zintra Sticks Corners are purpose-designed transition pieces that seamlessly join Sticks Bundles around external wall corners, ensuring a smooth and cohesive finish.

They are available in both Landscape and Portrait orientations to suit Narrow and Wide Sticks.

Available in 2 widths



Scan the QR code to find out more

Applications

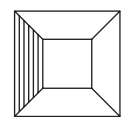

Walls



## Sticks Transition

Zintra Sticks Transition pieces are purpose-designed to seamlessly manage corners from walls to ceilings, ensuring a smooth and cohesive finish.

Available in both landscape and portrait orientations, Sticks Transition integrates effortlessly with Sticks Bundles to maintain design continuity.

Available in 2 widths



Scan the QR code to find out more

Applications

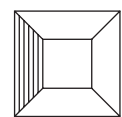

Walls

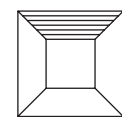

Ceilings

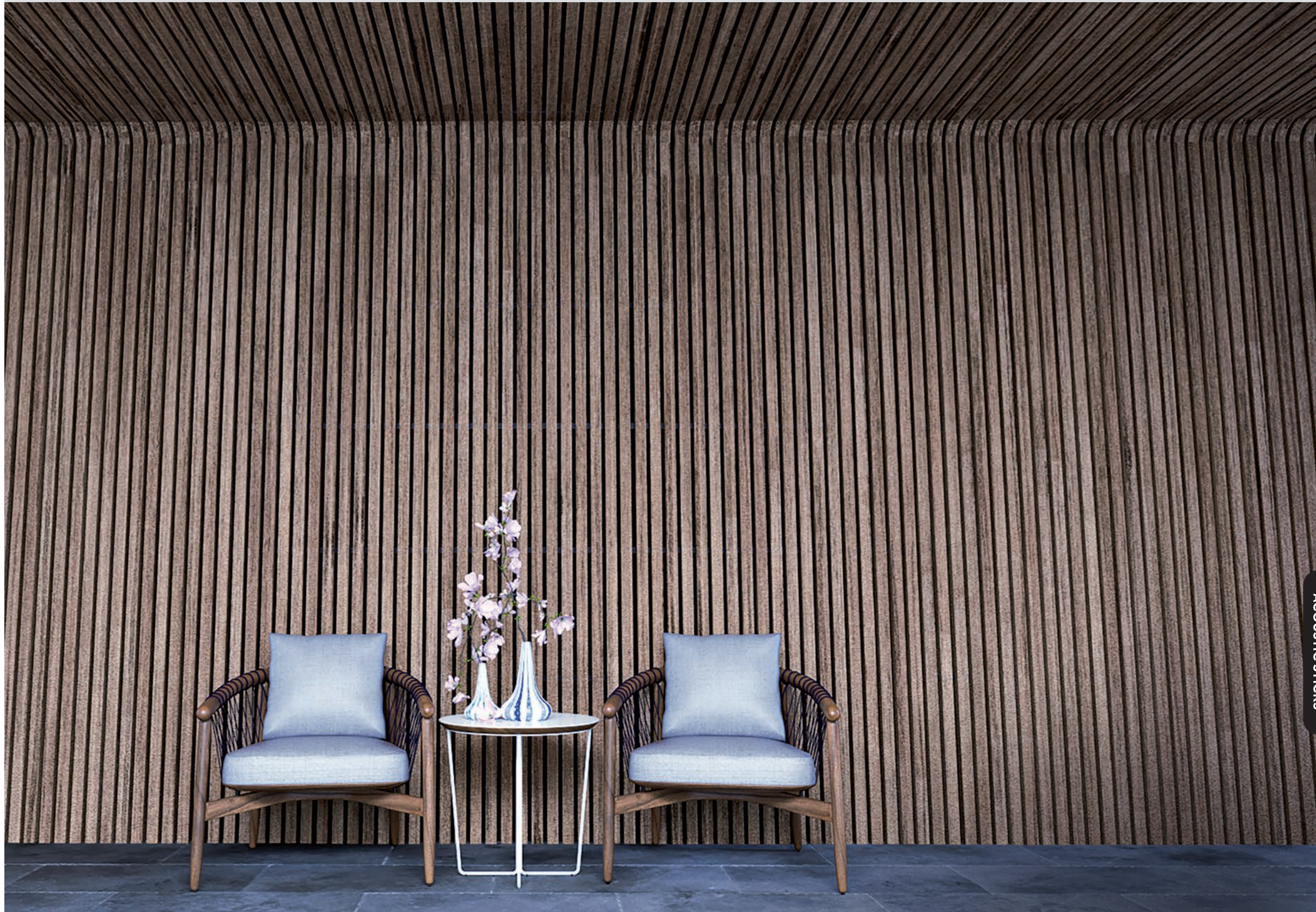

ACOUSTIC STICKS

Product: Zintra Sticks Bundle Narrow and Transition  
Orientation: Portrait | Color: Spotted Gum

## Sticks Trim

Zintra Sticks Trim ensures impeccable finishes around windows, doors, ceiling services, and GPOs.

Supplied as a separate right-angle piece, Sticks Trim is easily cut onsite for mitre or butt joints and is glued to Sticks sets to provide a seamless, matching finish to exposed ends.

Available in 2 widths



Scan the QR code to find out more

Applications

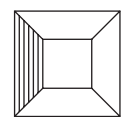

Walls

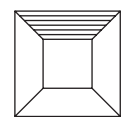

Ceilings



**Typical Landscape Transition Assembly**

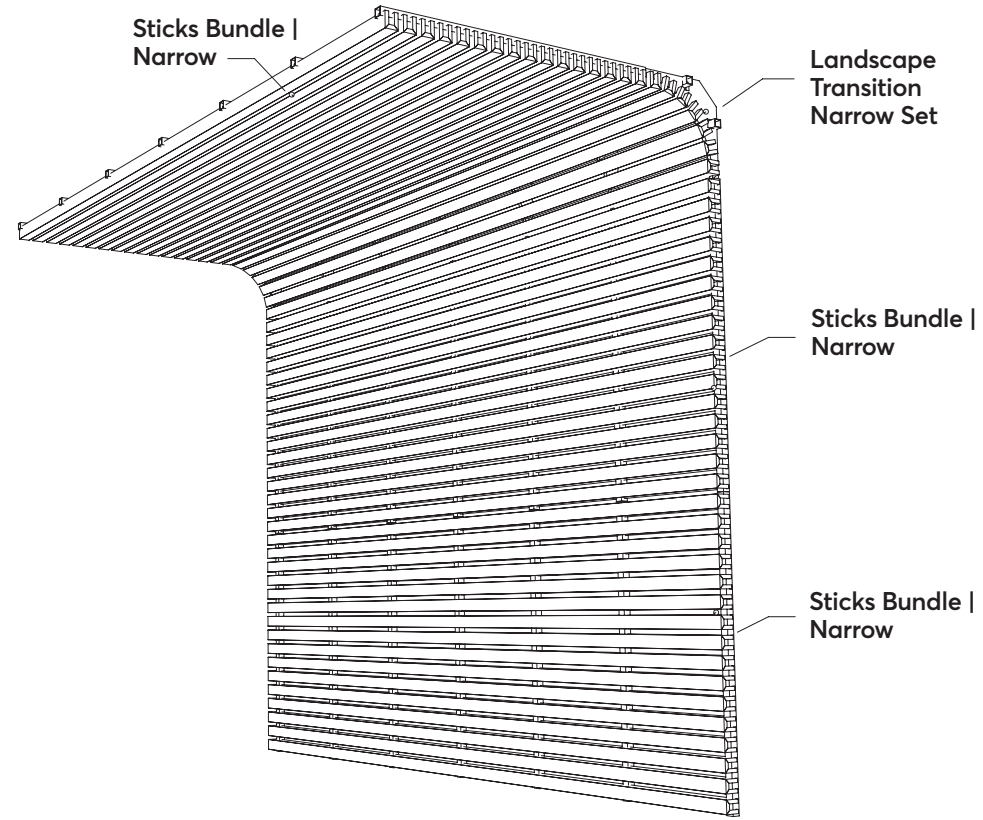

**Landscape Transition Narrow Set**

108" (2745mm) w x 11.65" (296mm) h

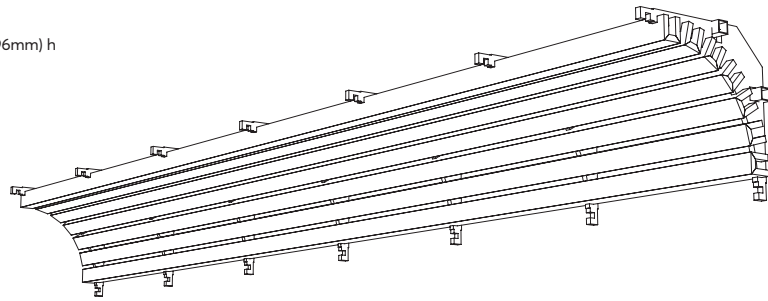

**Landscape Transition Wide Set**

108" (2745mm) w x 12.85" (326mm) h

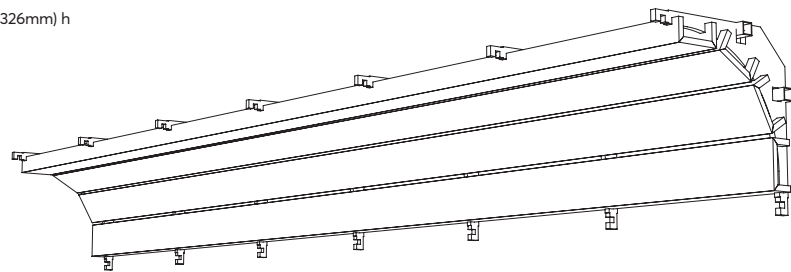

**Landscape External Corner Narrow Set**

37.5" (953mm) h x 6" (152mm) w

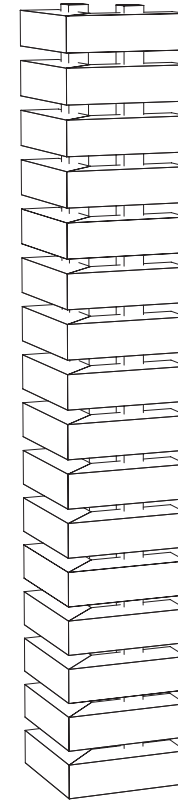

**Landscape External Corner Wide Set**

37.5" (953mm) h x 6" (152mm) w

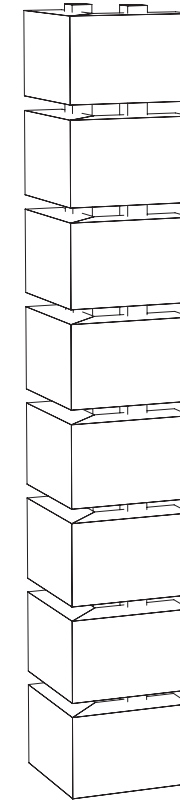

**Sticks Trim**

108" (2745mm) h x 2.9" (73mm) w x 2.9" (73mm) d

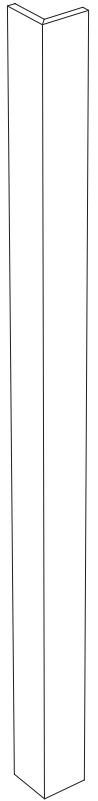

**Typical Landscape External Corner Assembly**

1.7" (42mm) wide stick profile

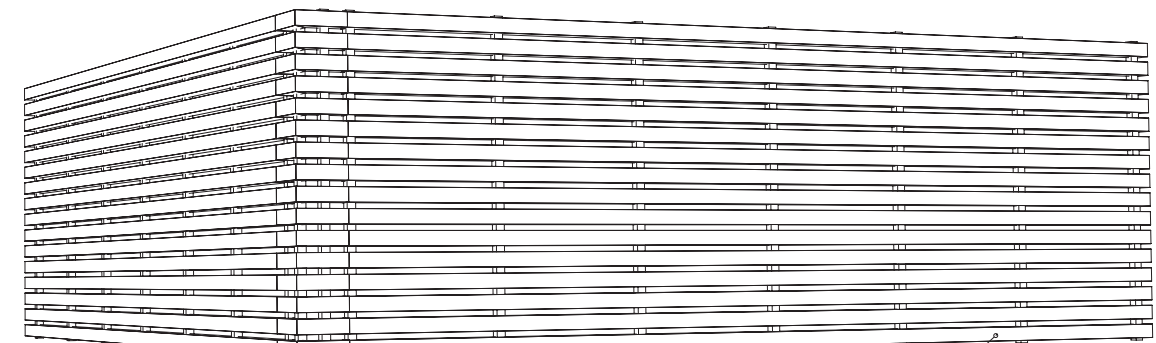

Sticks Bundle | Narrow      Landscape External Corner Narrow Set      Sticks Bundle | Narrow

### Sticks Bundle Narrow

37.5" (953mm) w x 108" (2745mm) h x 2.4" (61mm) d  
Individual Sticks – 1.7" (42mm) w x 1.9" (48.26mm) d

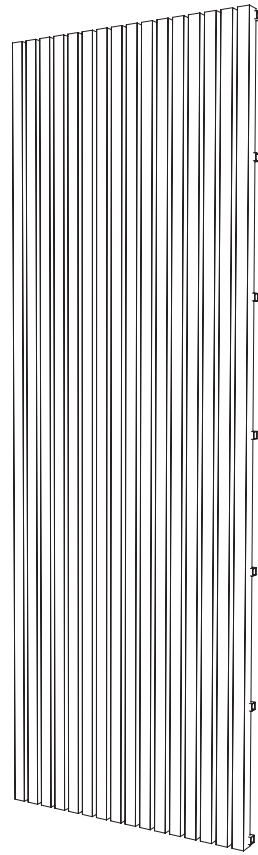

### Sticks Bundle Wide

37.5" (953mm) w x 108" (2745mm) h x 2.4" (61mm) d  
Individual Sticks – 4" (101mm) w x 1.9" (48.26mm) d

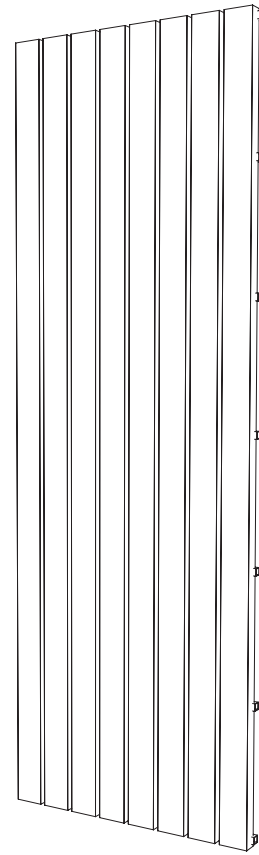

### Portrait External Corner Set

4" (101mm) w x 108" (2745mm) h

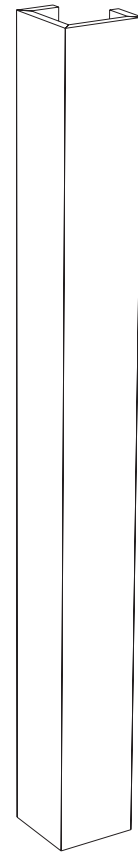

### Typical Portrait Transition Assembly

4" (101mm) wide stick profile

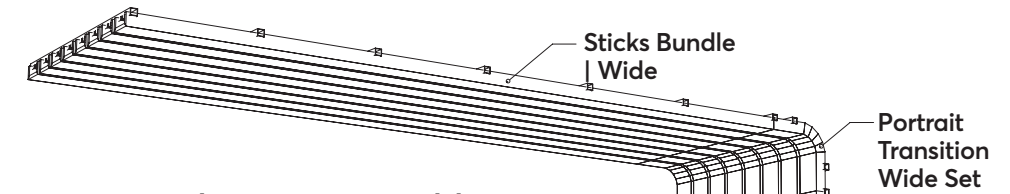

### Typical Portrait External Corner Assembly

4" (101mm) wide stick profile

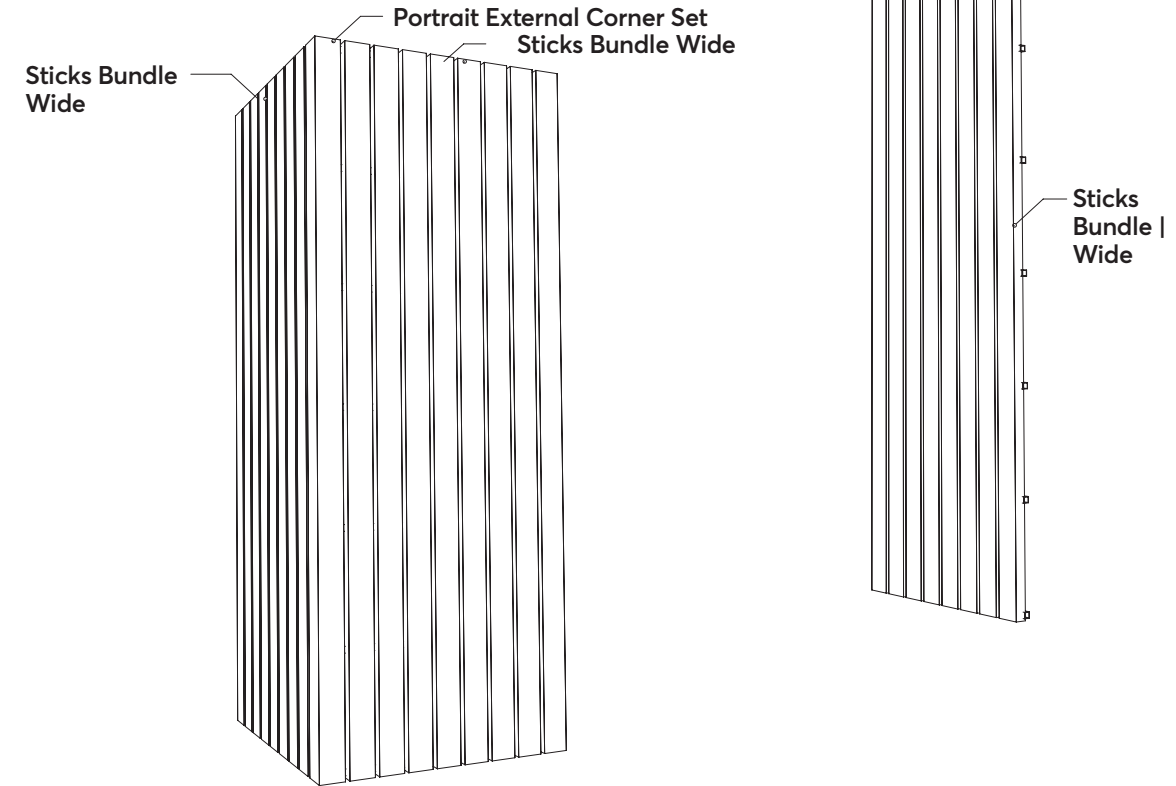

### Portrait Transition Narrow Set

37.5" (953mm) w x 11.4" (289mm) h

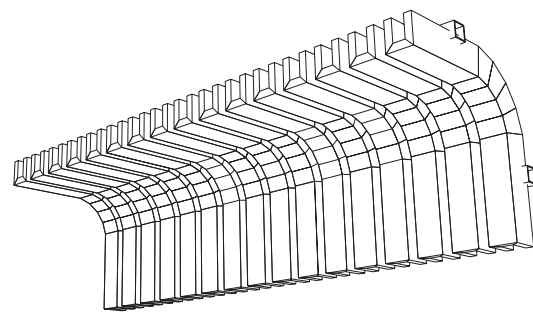

### Portrait Transition Wide Set

37.5" (953mm) w x 11.4" (289mm) h

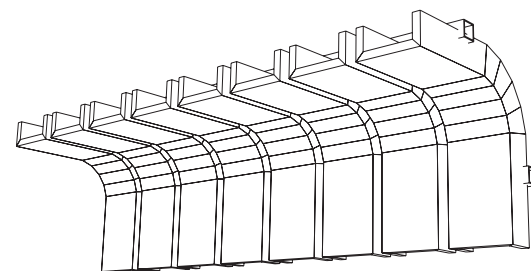

NOTE: Zintra Sticks are available as a complete system, which includes an aluminum frame and sticks, or as individual sticks. Offered in two widths and finishes, Zintra Sticks provide versatile design options for any space. A Suspension Kit for ceiling installations is also available. For a flawless finish around windows, doors, ceiling services, and sockets, Zintra Sticks pair perfectly with our precision-engineered Sticks Trim. This separate right-angle piece can be easily cut onsite for mitre or butt joints and glued to Sticks sets, ensuring a seamless finish on exposed ends.

### Sticks Bundles Specifications

Dimensions	See spread.	
Colors	Available in all 64 Colors, including Zintra Timber and Premium Prints. See p.11, p.12 and p.13. See p.214 for Powder Coat Colors.	
NRC Rating	Directly Mounted: 0.8	With 6" (152mm) Air Gap: 0.95
Aw Rating	Directly Mounted: 0.6	With 6" (152mm) Air Gap: 0.65
Suggested Installation	Ships flat packed except Sticks Trim. Assembly required. Check out the Technical Documents on our website to download the Installation Guide for more details.	
Customization	The Zintra Acoustic Solutions range is customizable to your project. Please get in touch with your local contact for details.	



## Independent Sticks

Zintra Independent Sticks have been designed to offer designers limitless creative possibilities.

Being trimmable in the field, they achieve flexibility without the noise and dust of real timber, allowing for the crafting of eye-catching feature walls, custom art installations, or asymmetrical patterns that span entire spaces.

Available in both Narrow and Wide options and a variety of finishes to suit your aesthetic preferences.

Available in 2 widths



Scan the QR code to find out more

Applications

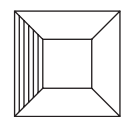

Walls

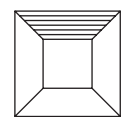

Ceilings





Product: Zintra Individual Sticks  
Color: Premium Wood Lacewood

### Independent Wide

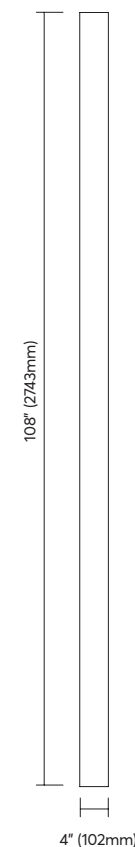

Front View

### Independent Narrow

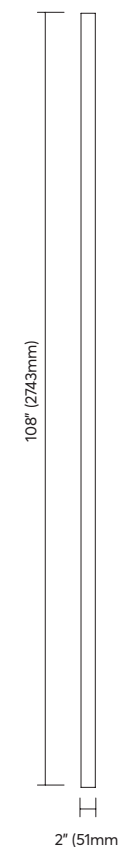

Front View

### Independent Sticks Specifications

Dimensions	Wide Set: 10 Sticks per Bundle System: 50" (1270mm) w x 108" (2743mm) h with 1" spacing Each Stick: 4" (102mm) wide	Narrow Set: 12 Sticks per Bundle System: 36" (914mm) w x 108" (2743mm) h with 1" spacing Each Stick 2" (48mm) wide
Colors	Available in all 64 Colors, including Zintra Timber and Premium Prints. See <a href="#">p.11</a> , <a href="#">p.12</a> and <a href="#">p.13</a>	
NRC Rating	Directly Mounted: 0.80	With 6" (152mm) Air Gap: 0.95
Aw Rating	Directly Mounted: 0.60	With 6" (152mm) Air Gap: 0.65
Suggested Installation	Ships flat packed. Assembly required. Check out the Technical Documents on our website to download the Installation Guide for more details.	
Additional Comments	Minimum 1" (24mm) spacing required.	
Customization	The Zintra Acoustic Solutions range is customizable to your project. Please get in touch with your local contact for details.	

## Quadratic Sticks

Zintra Quadratic Sticks are designed to enhance acoustics through the innovative use of a quadratic residue sequence.

Each pattern comprises eight sticks, repeating systematically to optimize acoustic outcomes. Variable heights strategically enhance sound absorption while minimizing reverberation, ensuring more evenly distributed sound energy throughout the room. This reduces echoes and creates enhanced speech clarity.

Available in 2 widths



Scan the QR code to find out more

Applications

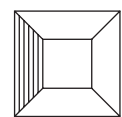

Walls

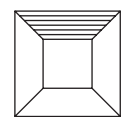

Ceilings





Product: Zintra Quadratic Sticks w/ endcaps  
 Orientation: Landscape | Color: Smoke

## Quadratic Sticks

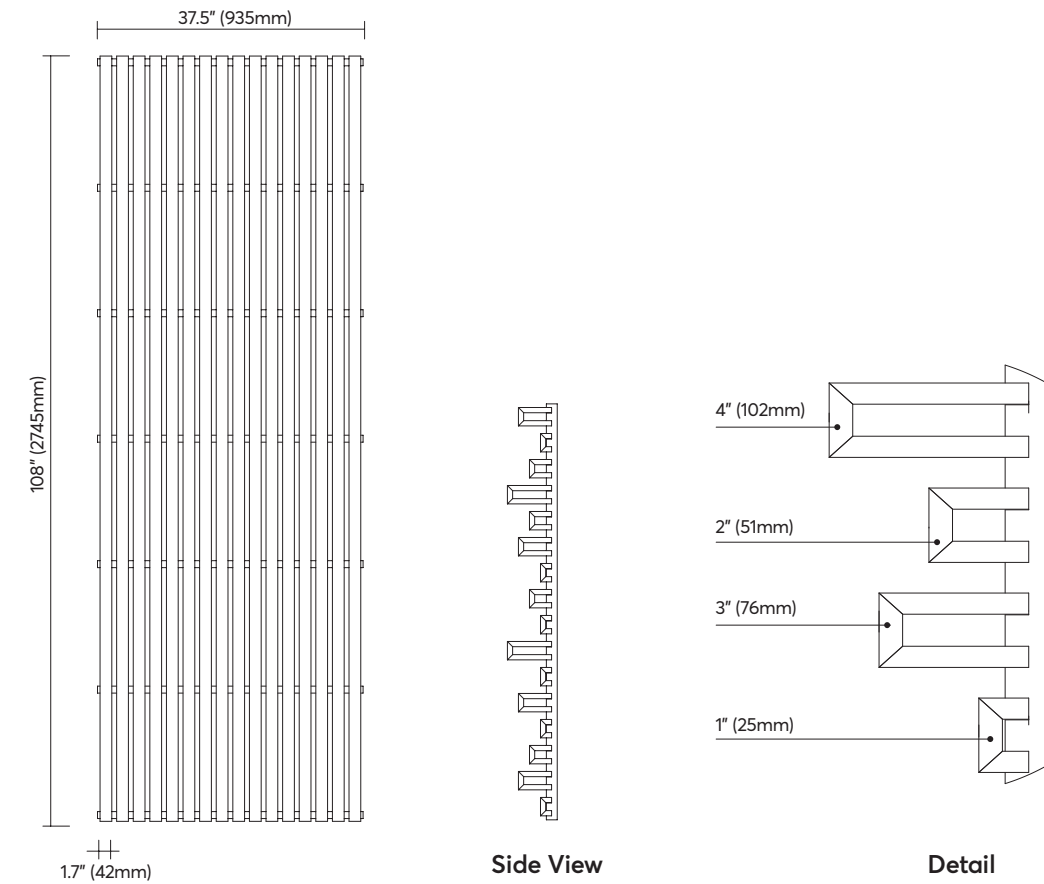

## Quadratic Sticks Specifications

Dimensions	All sticks are: 1.7" w (42 mm) x 108" (2743mm)   Set includes: (x6) 1" (25mm) deep sticks, (x4) 2" (51mm) deep sticks, (x4) 3" (76mm) deep sticks, (x2) 4" (102mm) deep sticks
Colors	Available in all 64 Colors, including Zintra Timber and Premium Prints. See p.11, p.12 and p.13. See p.214 for Powder Coat Colors.
NRC Rating	0.95
Aw Rating	0.80
Suggested Installation	Ships flat packed except 1" (25mm) Quadratic Stick. Assembly required. Check out the Technical Documents on our website to download the Installation Guide for more details.
Customization	The Zintra Acoustic Solutions range is customizable to your project. Please get in touch with your local contact for details.

## Double Sided Sticks

Zintra Double Sided Sticks provide a versatile solution for creating and rearranging spaces, meeting the increasing demand for space dividers without affecting walls or ceilings.

Perfect for displays, reception areas, or breakout spaces, Double Sided Sticks are available as Narrow or Wide Sticks in both Portrait and Landscape orientations. The Landscape orientation also comes in a half-height version, which is perfect as a privacy screen. Installation is straightforward and can be modified onsite, making Zintra Double Sided Sticks a simple and effective way to transform spaces.

Available in 3 designs



Scan the QR code to find out more

Applications

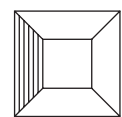

Walls



### Double Sided Portrait - Wide

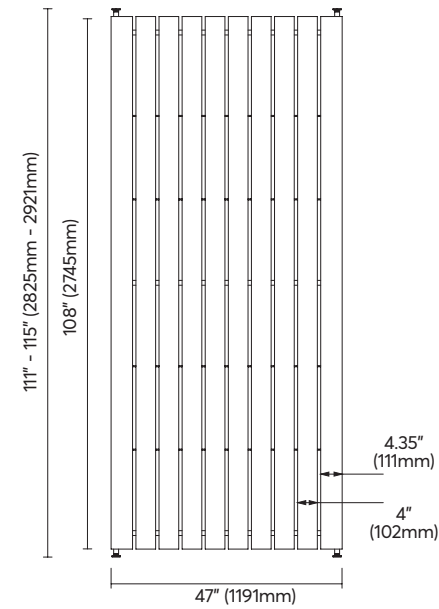

### Double Sided Landscape - Wide Half Set

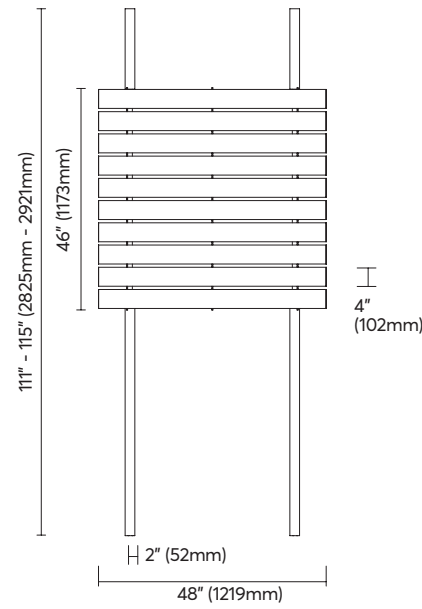

### Double Sided Landscape - Wide Full Set

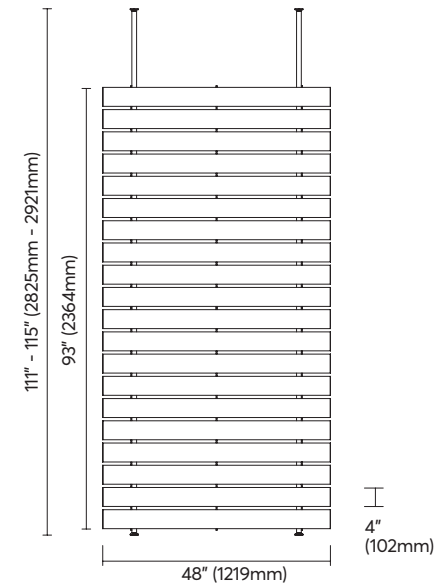

### Double Sided Portrait - Narrow

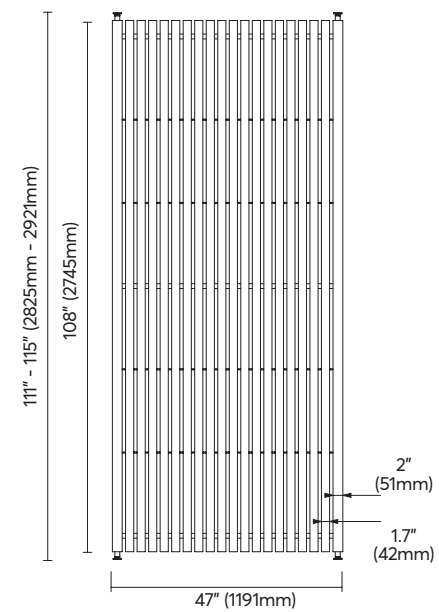

### Double Sided Landscape - Narrow Half Set

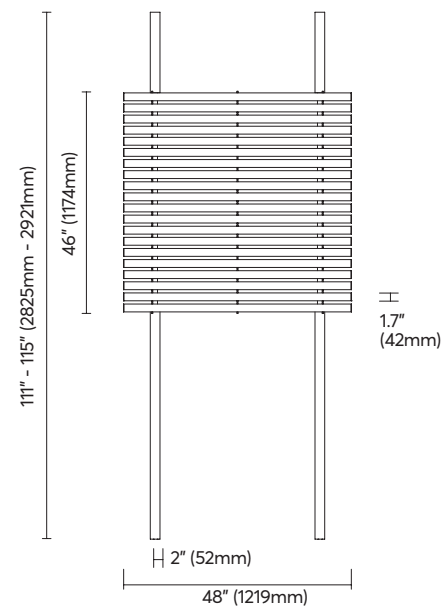

### Double Sided Landscape - Narrow Full Set

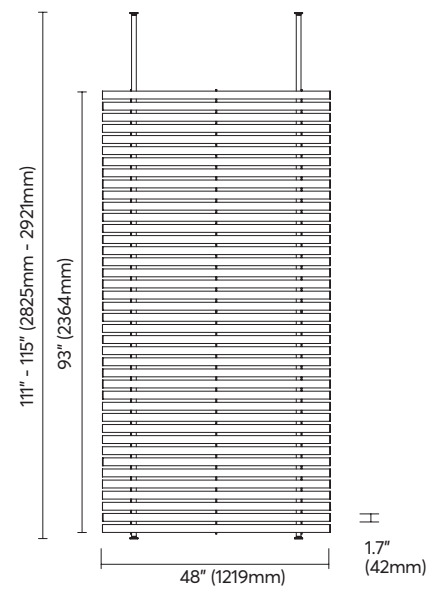

Product: Zintra Double Sided Sticks Narrow  
Orientation: Portrait | Color: Premium Wood Poplar

### Double Sided Sticks Specifications

Dimensions	Portrait:	Landscape Full Height:	Landscape Half Height:
	<b>Narrow Set 20 pcs</b> 47" (1191mm) w x 111" (2820mm) h x 3.8" (96.5mm) d End Stick Width 2" (51mm) Middle Stick Width 1.7" (42mm)	<b>Narrow Set 40 pcs</b> 48" (1219mm) w x 111" (2820mm) h x 3.8" (96.5mm) d Each Stick Width 1.7" (42mm)	<b>Narrow Set 20 pcs</b> 48" (1219mm) w x 46" (1174mm) h x 3.8" (96.5mm) d Overall System: 48" w x 111" h Each Stick Width 1.7" (42mm)
	<b>Wide Set 10pcs</b> 47" (1191mm) w x 111" (2820mm) h x 3.8" (96.5mm) d End Stick Width 4.35" (111mm) Middle Stick Width 4" (102mm)	<b>Wide Set 20 pcs</b> 48" (1219mm) w x 111" (2820mm) h x 3.8" (96.5mm) d Each Stick Width 4" (102mm)	<b>Wide Set 10 pcs</b> 48" (1219mm) w x 46" (1174mm) h x 3.8" (96.5mm) d Overall System: 48" w x 111" h Each Stick Width 4" (102mm)
Colors	Available in all 64 Colors, including Zintra Timber and Premium Prints. See p.11, p.12 and p.13. See p.214 for Powder Coat Colors.		
NRC Rating	0.85		
Aw Rating	0.70		
Suggested Installation	Ships flat packed. Assembly required. Check out the Technical Documents on our website to download the Installation Guide for more details.		
Customization	The Zintra Acoustic Solutions range is customizable to your project. Please get in touch with your local contact for details.		

NOTE: Overall height range 111"- 115" max with adjustable feet.

## Curved Sticks

Zintra Curved Sticks introduce a captivating and affordable curved dimension to flat surfaces, which are typically challenging and costly to achieve.

Zintra Curved Sticks comprise a single set of sticks that allow you to create a simple curve, or you can combine multiple sets to design a dramatic ceiling or wall wave feature.

Available in 2 widths



Scan the QR code to find out more

Applications

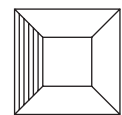

Walls

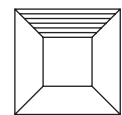

Ceilings





Product: Zintra Curved Sticks  
Narrow Suspended | Color: Frost

### Curved Narrow

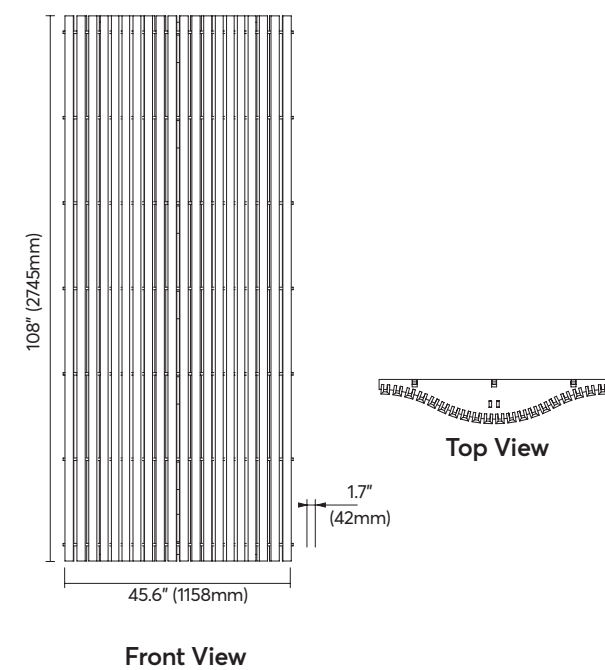

### Curved Wide

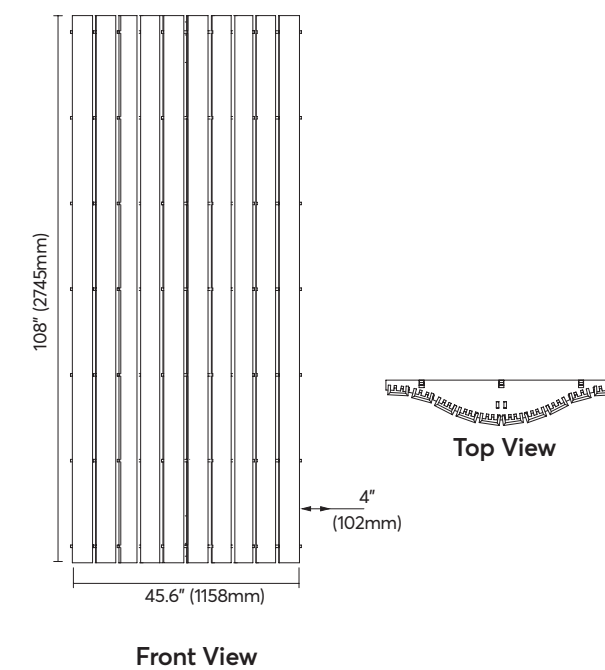

### Curved Sticks Specifications

Dimensions	45.6" (1158mm) w x 108" (2743mm) h Each Stick Narrow: 1.7" (42mm) Wide: 4" (102mm)
Colors	Available in all 64 Colors, including Zintra Timber and Premium Prints. See p.11, p.12 and p.13. See p.214 for Powder Coat Colors.
NRC Rating	0.95
Aw Rating	0.60
Suggested Installation	Ships flat packed. Assembly required. Check out the Technical Documents on our website to download the Installation Guide for more details.
Customization	The Zintra Acoustic Solutions range is customizable to your project. Please get in touch with your local contact for details.



# Tiles

Zintra Tiles feature a wide array of designs from simple to intricate across four unique styles, along with options for single-layer, double-layer, and large formats. Perfect for improving sound quality in offices, schools, hospitals, and public areas. Designed for effortless delivery, installation, and excellent acoustics, use them as accent pieces or for full coverage.



TILES

## Plain Tiles

With 14 unique shapes, available in all 64 colors, Zintra Plain Tiles provide endless design possibilities.

Pair Plain Tiles with Etch Tiles or mix and match colors for dramatic customized effects. The versatile nature of Plain Tiles allows for the effortless creation of environments that are both aesthetically pleasing and acoustically optimized.

### Available in 14 Designs Applications



Scan the QR code to find out more

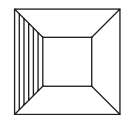

Walls

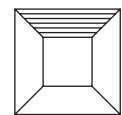

Ceilings





Product: Zintra Plain Tiles Tablet C  
Color: Premium Wood Australian Walnut

### Tablet A

24 Tiles / set, 35.52 SF (3.36 m<sup>2</sup>)

#### Front View

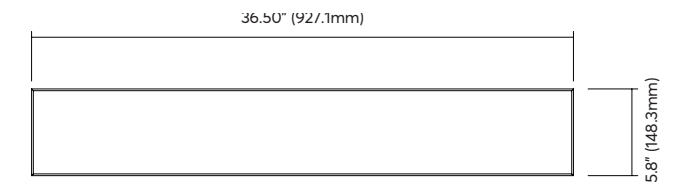

### Tablet B

15 Tiles / set, 34.65 SF (3.15 m<sup>2</sup>)

#### Front View

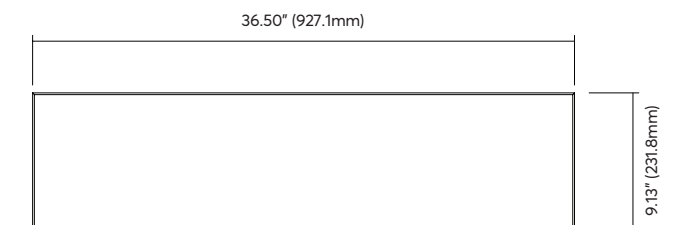

### Tablet C

9 Tiles / set, 33.3 SF (3.06 m<sup>2</sup>)

#### Front View

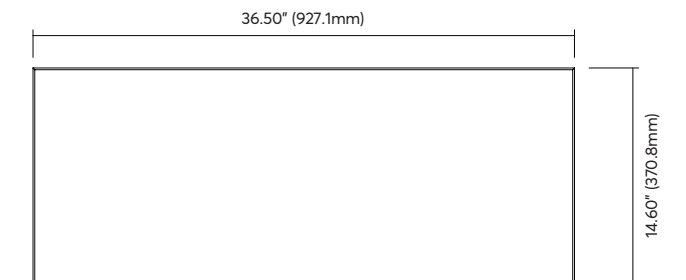

NOTE: A, B and C all have a chamfer edge.

### Battleaxe

13 tiles / set, 25.2 SF (2.3m<sup>2</sup>)

Front View

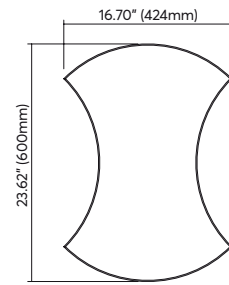

### Chevron

10 tiles / set, 31.7 SF (2.9m<sup>2</sup>)

Front View

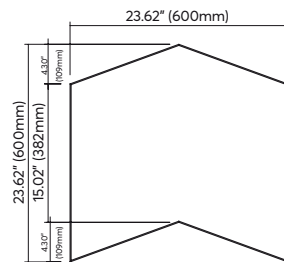

### Jigsaw

8 tiles / set, 23.7 SF (2.2m<sup>2</sup>)

Front View

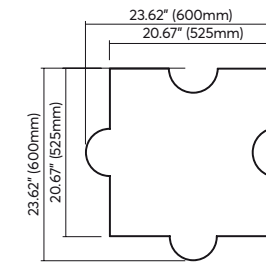

### Trapezium

15 tiles / set, 31.8 SF (3m<sup>2</sup>)

Front View

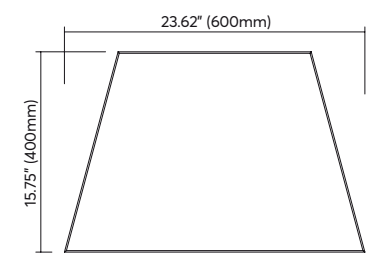

### Diamond

20 tiles / set, 25.8 SF (2.4m<sup>2</sup>)

Front View

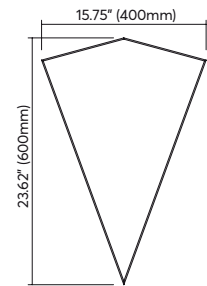

### Herringbone

12 tiles / set, 30.1 SF (2.8m<sup>2</sup>)

Front View

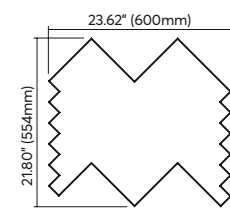

### Geometrics

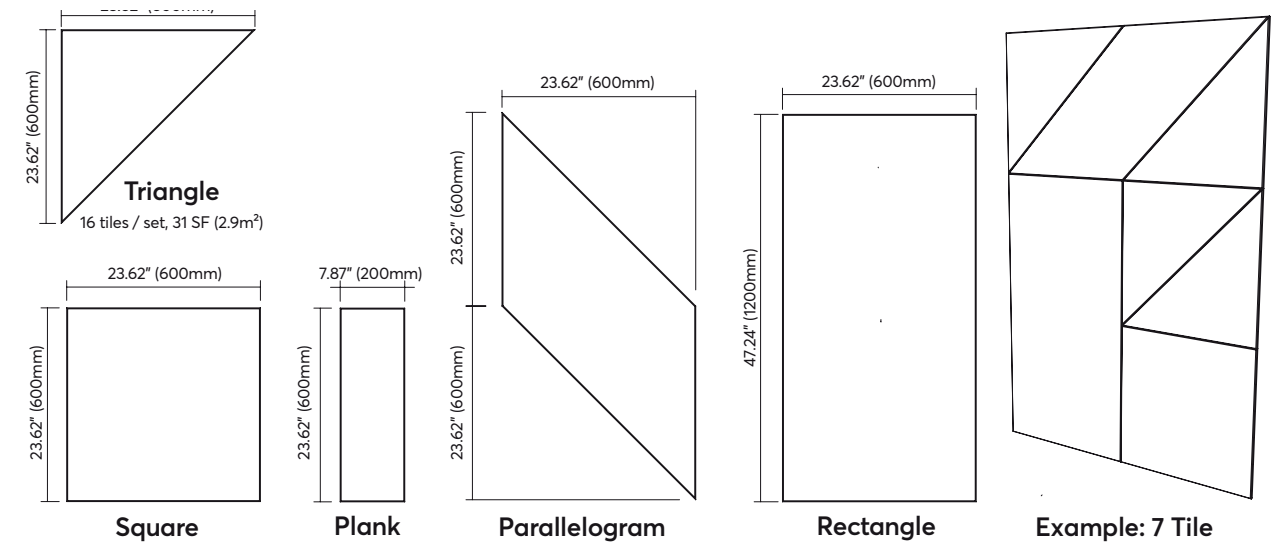

### Hexagon

10 tiles / set, 24.6 SF (2.3m<sup>2</sup>)

Front View

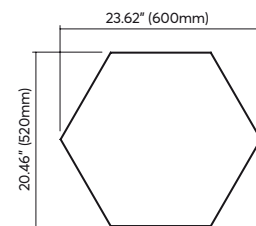

### Hourglass

5 tiles / set, 21.8 SF (2m<sup>2</sup>)

Front View

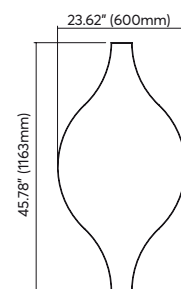

### Plain Tiles Specifications

Dimensions	See above.
Colors	Available in all 64 Colors, including Zintra Timber and Premium Prints. See <a href="#">p.11</a> , <a href="#">p.12</a> and <a href="#">p.13</a>
NRC Rating	Directly Mounted: 0.45
Aw Rating	Directly Mounted: 0.30
Suggested Installation	Supplied as a set of individual tiles. Arrange as required and fix to the wall with construction adhesive. As an alternative solution, use a Non-Destructive Removable Fixing (NDRF) (sold separately). See <a href="#">p.200</a> for hardware detail. Check out the Technical Documents on our website to download the Installation Guide for more details.
Additional Comments	Also available with Digital Print. Not suitable as a free standing product.
Customization	The Zintra Acoustic Solutions range is customizable to your project. Please get in touch with your local contact for details.

## Box Tiles

Zintra Box Tiles do more than just cover walls—they imbue spaces with texture, depth, and bold definition while delivering superior acoustic benefits, making them an ideal all-around solution for enhancing the ambiance of restaurants, hotels, or office spaces.

Available in small to large formats, Box Tiles allow you to choose from Zintra's full color range to effortlessly complement any design theme. Whether you're aiming for a seamless wall-to-wall installation or a striking acoustic art feature, Box Tiles offer the flexibility to achieve your vision.

Available in 10 Designs Applications



Scan the QR code to find out more

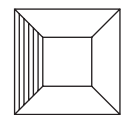

Walls

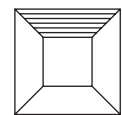

Ceilings







Product: Zintra Box Tiles Square  
Color: Pewter, Smoke, Chambray & Ivory

184.



Product: Zintra Box Tiles Hex | Color: Smoke, Slate & Fossil

ZINTRA 185.

### Emerald 8x96

3 tiles / set, 8" (203mm) w x 96" (2438mm) h x 4" (102mm) d  
16 SF (1.5m<sup>2</sup>)

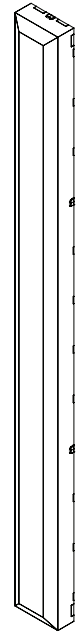

### Emerald 16x96

2 tiles / set, 16" (406mm) w x 96" (2438mm) h x 4" (102mm) d  
21.34 SF (1.98m<sup>2</sup>)

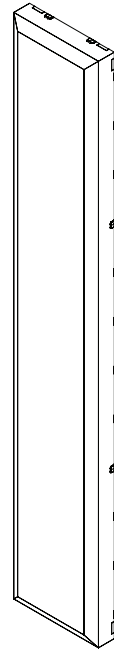

### Emerald 32x96

1 tile / set, 32" (813mm) w x 96" (2438mm) h x 4" (102mm) d  
21.34 SF (1.98m<sup>2</sup>)

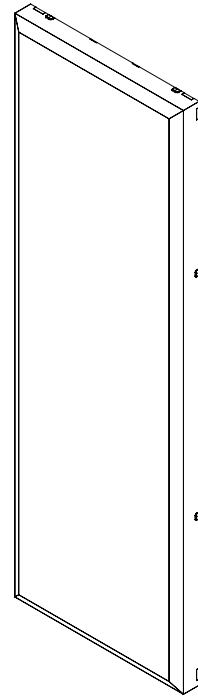

### Emerald 16x24

6 tiles / set, 16" (406mm) w x 24" (610mm) h x 4" (102mm) d  
16 SF (1.5m<sup>2</sup>)

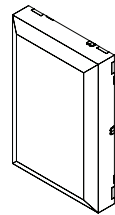

### Emerald 32x32

2 tiles / set, 32" (813mm) w x 32" (813mm) h x 4" (102mm) d  
14.22 SF (1.32m<sup>2</sup>)

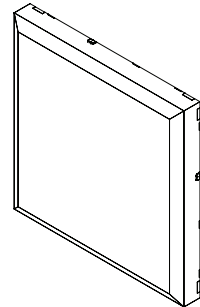

### Emerald 16x16

8 tiles / set, 16" (406mm) w x 16" (406mm) h x 4" (102mm) d  
14.25 SF (1.36m<sup>2</sup>)

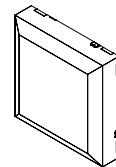

### Emerald 32x48

2 tiles / set, 32" (813mm) w x 48" (1219mm) h x 4" (102mm) d  
21.34 SF (1.98m<sup>2</sup>)

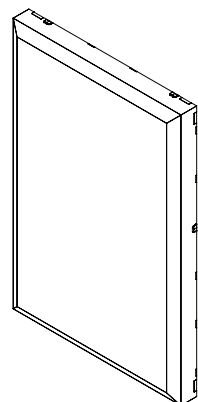

### Emerald 8x48

5 tiles / set, 8" (203mm) w x 48" (1219mm) h x 4" (102mm) d  
13.35 SF (1.25m<sup>2</sup>)

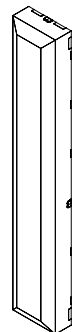

### Emerald 16x48

3 tiles / set, 16" (406mm) w x 48" (1219mm) h x 4" (102mm) d  
16 SF (1.5m<sup>2</sup>)

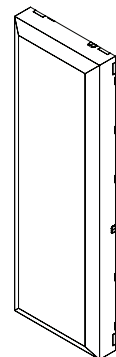

### Diamond

15 tiles / set, 11.7 SF (1.1m<sup>2</sup>)  
9.5" (242mm) w x 15" (381mm) h x 3" (76mm) d / tile

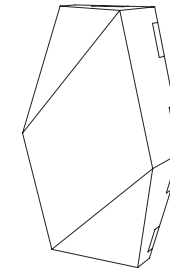

### Hex

12 tiles / set, 12.1 SF (1.1m<sup>2</sup>)  
15" (381mm) w x 13" (330mm) h x 3" (76mm) d / tile

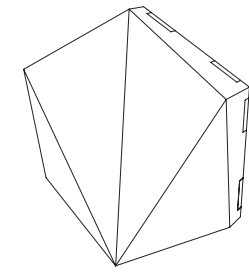

### Pitched

10 tiles / set, 17.8 SF (1.7m<sup>2</sup>)  
15" (406mm) x 15" (406mm) h x 3" (76mm) d / tile

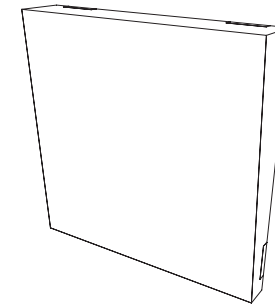

### Square 8x8

21 tiles / set, 9.33 SF (0.87m<sup>2</sup>)  
8" (203mm) x 8" (203mm) h  
Available in 1.5" (38mm), 2.3" (57mm), 3" (76mm) d / tile

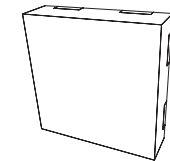

### Square 16x16

10 tiles / set, 17.8 SF (1.65m<sup>2</sup>)  
16" (406mm) x 16" (406mm) h  
Available in 1.5" (38mm), 2.3" (57mm), 3" (76mm) d / tile

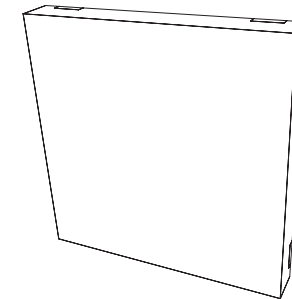

### Rectangle 8x16

14 tiles / set, 12.44 SF (1.16m<sup>2</sup>)  
8" (203mm) x 16" (406mm) h  
Available in 1.5" (38mm), 2.3" (57mm), 3" (76mm) d / tile

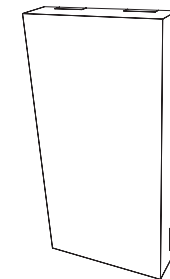

### Box Tiles Specifications

Dimensions	See above.
Colors	Available in all 64 Colors, including Zintra Timber and Premium Prints. See p.11, p.12 and p.13
NRC Rating	Directly Mounted: 1.15
Aw Rating	Directly Mounted: 1.00
Suggested Installation	Supplied as a set of individual tiles. Arrange as required and fix to the wall with construction adhesive. As an alternative solution, use a Non-Destructive Removable Fixing (NDRF) (sold separately). See p.200 for hardware detail. Check out the Technical Documents on our website to download the Installation Guide for more details.
Customization	The Zintra Acoustic Solutions range is customizable to your project. Please get in touch with your local contact for details.



## Etch Tiles

Zintra Etch Tiles combine sophisticated design with superior sound absorption. Precision-cut V-grooves create captivating patterns that add depth and dimension to any room, with Zintra's wide color palette offering endless possibilities.

Perfect for modern interiors, Etch Tiles can be used as a standalone feature or seamlessly integrated with Zintra Plain Tiles for a cohesive look.

Available in 15 Designs



Scan the QR code to find out more

Applications

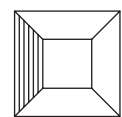

Walls

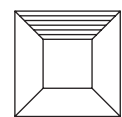

Ceilings





Product: Zintra Etch Tile Crossbar  
Color: Elderberry (front), Parchment (back)



Product: Zintra Etch Tile Link  
Color Parchment (front), Saffron (back)



Product: Zintra Etch Tile Shadow Box | Color: Premium Material Terrazzo Dark (front), Parchment (back)



Product: Zintra Etch Tile Herringbone | Color: Pebble

### Crossbar A

9 tiles / set, 33.3 SF (3.06 m<sup>2</sup>)

Front View

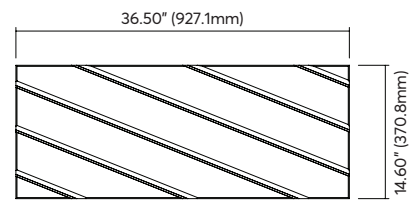

### Crossbar B

9 tiles / set, 33.3 SF (3.06 m<sup>2</sup>)

Front View

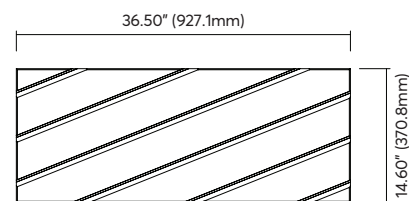

### Fluted

9 tiles / set, 35.37 SF (3.24 m<sup>2</sup>)

Front View

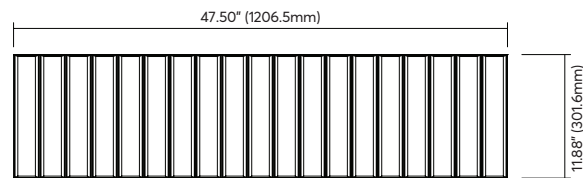

### Shadow Box

21 tiles / set, 35.07 SF (3.15 m<sup>2</sup>)

Front View

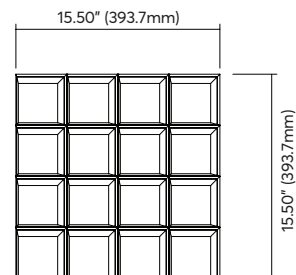

### Link A

24 tiles / set, 35.52 SF (3.36 m<sup>2</sup>)

Front View

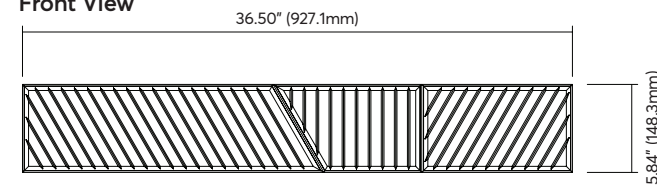

### Link B

24 tiles / set, 35.52 SF (3.36 m<sup>2</sup>)

Front View

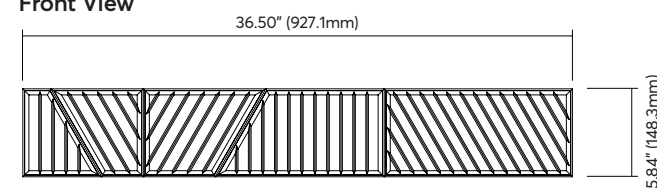

### Louver

9 tiles / set, 35.37 SF (3.24 m<sup>2</sup>)

Front View

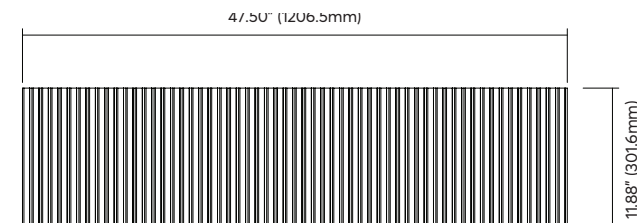

### Battleaxe

13 tiles / set, 25.2 SF (2.3m<sup>2</sup>)

Front View

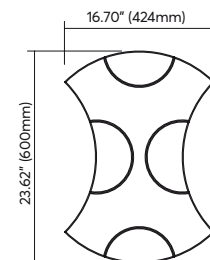

### Chevron

10 tiles / set, 31.7 SF (2.9m<sup>2</sup>)

Front View

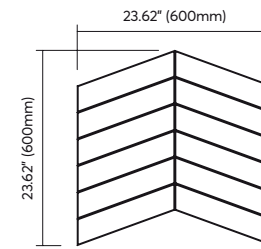

### Diamond

20 tiles / set, 25.8 SF (2.4m<sup>2</sup>)

Front View

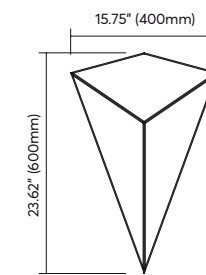

### Herringbone

12 tiles / set, 30.1 SF (2.8m<sup>2</sup>)

Front View

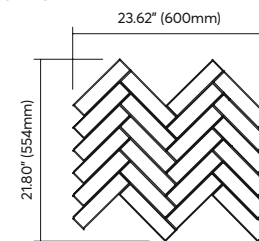

### Hexagon

10 tiles / set, 24.6 SF (2.3m<sup>2</sup>)

Front View

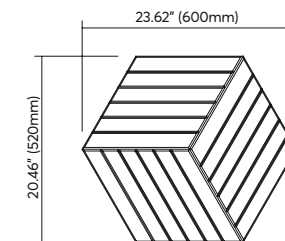

### Plank

24 tiles / set, 33.5 SF (3.1m<sup>2</sup>)

Front View

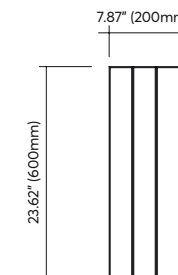

### Trapezium

15 tiles / set, 31.8 SF (2.9m<sup>2</sup>)

Front View

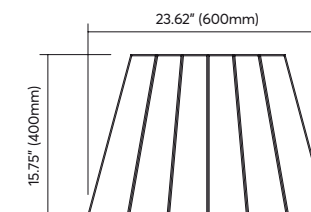

### Hourglass

5 tiles / set, 21.8 SF (2m<sup>2</sup>)

Front View

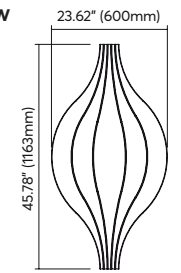

### Square

8 tiles / set, 31 SF (2.9m<sup>2</sup>)

Front View

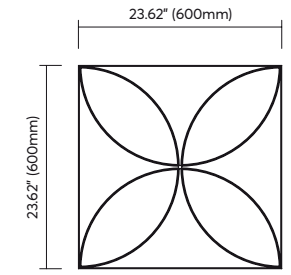

### Triangle

16 tiles / set, 31 SF (2.9m<sup>2</sup>)

Front View

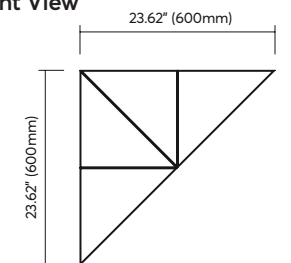

### Etch Tiles Specifications

Dimensions	See above.
Colors	Available in all 64 Colors, including Zintra Timber and Premium Prints. See <a href="#">p.11</a> , <a href="#">p.12</a> and <a href="#">p.13</a>
NRC Rating	Directly Mounted: 0.45 - 0.75
Aw Rating	Directly Mounted: 0.30 - 0.60
Suggested Installation	Supplied as a set of individual tiles. Arrange as required and fix to the wall with construction adhesive. As an alternative solution, use a Non-Destructive Removable Fixing (NDRF) (sold separately). See <a href="#">p.200</a> for hardware detail. Check out the Technical Documents on our website to download the Installation Guide for more details.
Additional Comments	Also available with Digital Print. Not suitable as a free standing product.
Customization	The Zintra Acoustic Solutions range is customizable to your project. Please get in touch with your local contact for details.

## Pattern Tiles

Discover the versatility and creative potential of Zintra Pattern Tiles, where timeless elegance meets contemporary flair.

Each intricately cut tile, crafted from high-quality Zintra material, mounts onto a back panel in your choice of matching or contrasting Zintra colors. This adds style, texture, contrast, and depth to your walls or ceilings while offering superior sound absorption.

Available in 10 Designs



Scan the QR code to find out more

Applications

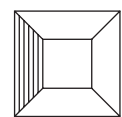

Walls

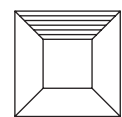

Ceilings





Product: Zintra Pattern Tile Billet | Color: Premium Material Cast Concrete (front), Grass (back)

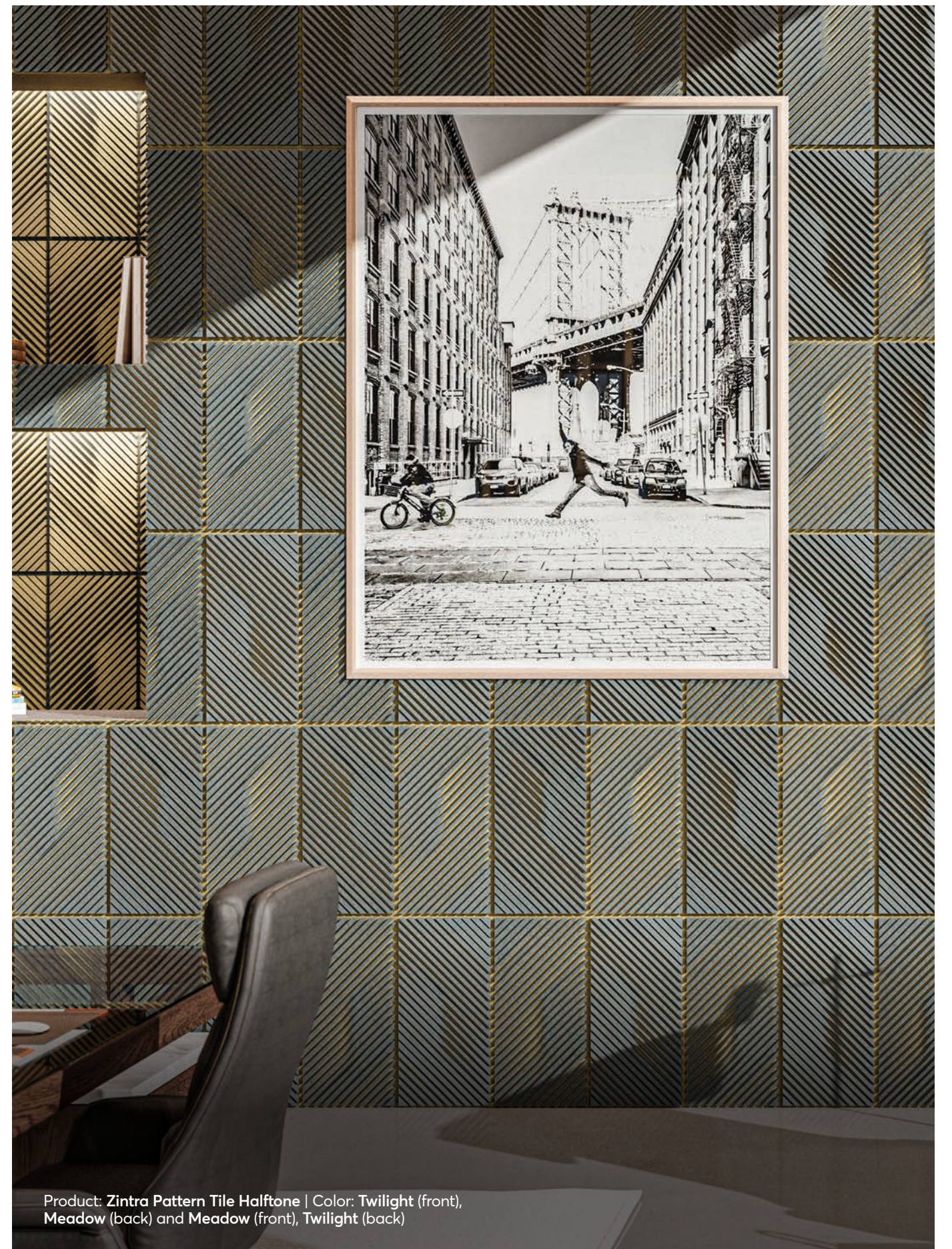

Product: Zintra Pattern Tile Halftone | Color: Twilight (front), Meadow (back) and Meadow (front), Twilight (back)



200. Product: Zintra Pattern Tile Entwine | Color: Pebble (front), Midnight (back)



Product: Zintra Pattern Tile Leap  
Color: Smoke (front), Slate (back)

### Billet A

9 tiles / set, 35.37 SF (3.24m<sup>2</sup>)

#### Front View

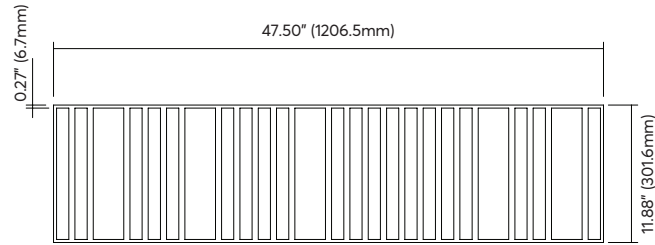

### Billet B

9 tiles / set, 35.37 SF (3.24m<sup>2</sup>)

#### Front View

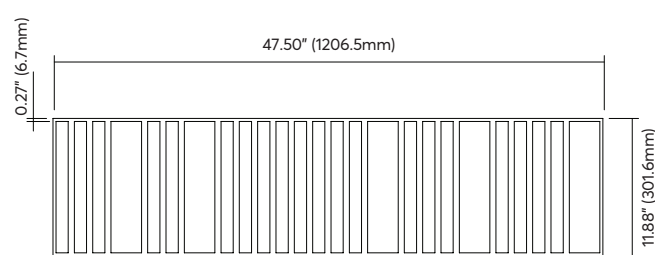

### Groove A

9 tiles / set, 33.3 SF (3.06m<sup>2</sup>)

#### Front View

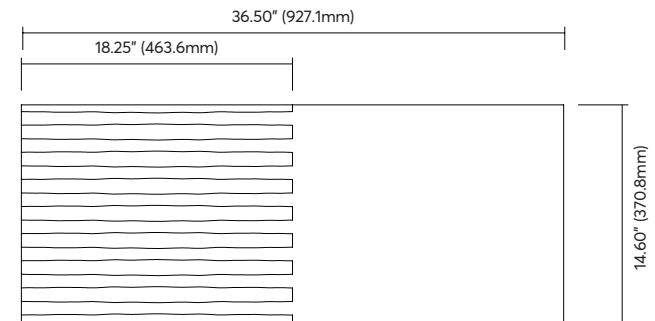

### Groove B

9 tiles / set, 33.3 SF (3.06m<sup>2</sup>)

#### Front View

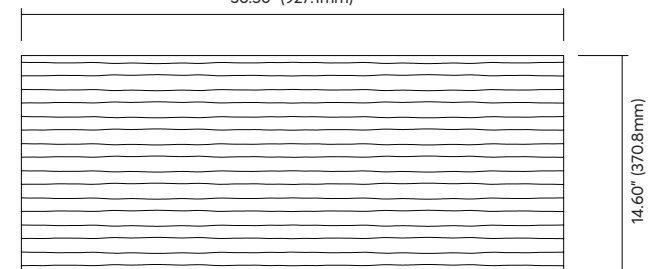

### Halftone A

18 tiles / set, 35.46 SF (3.24m<sup>2</sup>)

#### Front View

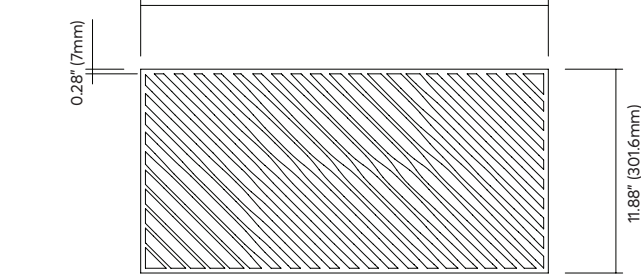

### Halftone B

18 tiles / set, 35.46 SF (3.24m<sup>2</sup>)

#### Front View

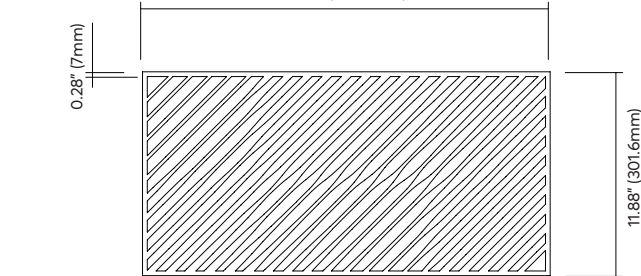

### Pathway A

21 tiles / set, 35.07 SF (3.15m<sup>2</sup>)

#### Front View

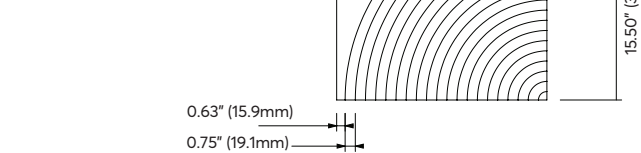

### Pathway B

21 tiles / set, 35.07 SF (3.15m<sup>2</sup>)

#### Front View

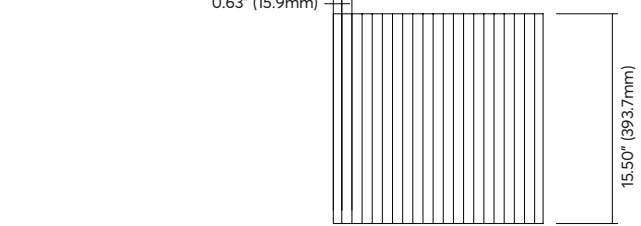

### Pathway C

21 tiles / set, 35.07 SF (3.15m<sup>2</sup>)

#### Front View

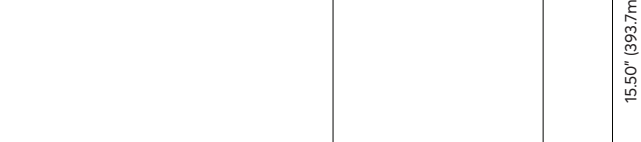

### Arch

16 tiles / set, 25.7 SF (2.4m<sup>2</sup>)

#### Front View

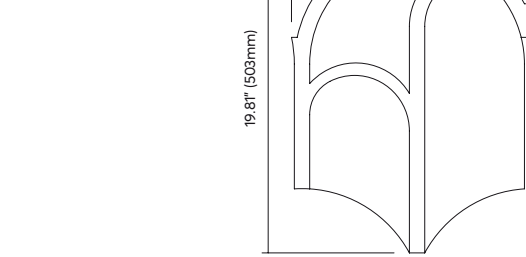

### Entwine

10 tiles / set, 22.8 SF (2.1m<sup>2</sup>)

#### Front View

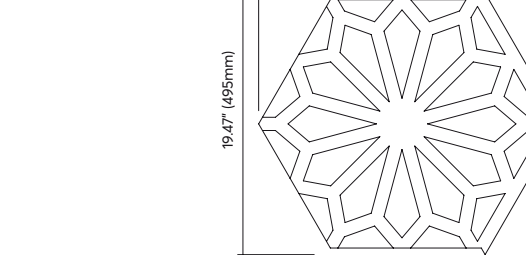

### Leap

10 tiles / set, 22.8 SF (2.1m<sup>2</sup>)

#### Front View

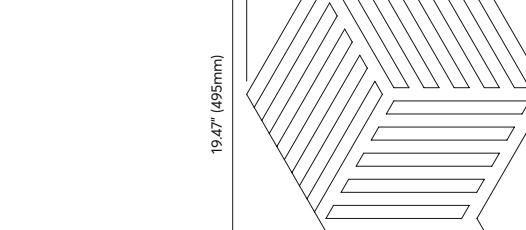

### Lotus

10 tiles / set, 25.2 SF (2.3m<sup>2</sup>)

#### Front View

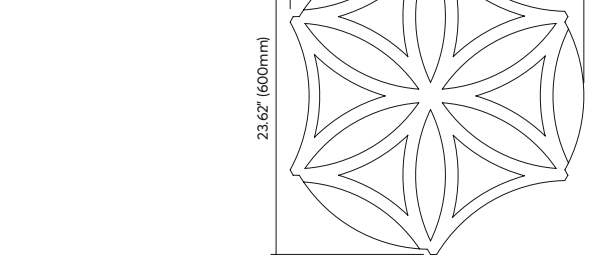

### Striae

14 tiles / set, 29.8 SF (2.8m<sup>2</sup>)

#### Front View

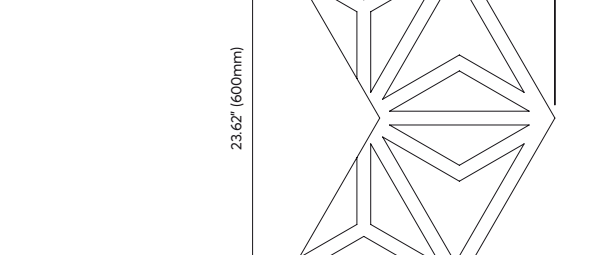

### Surge

8 tiles / set, 24.5 SF (2.3m<sup>2</sup>)

#### Front View

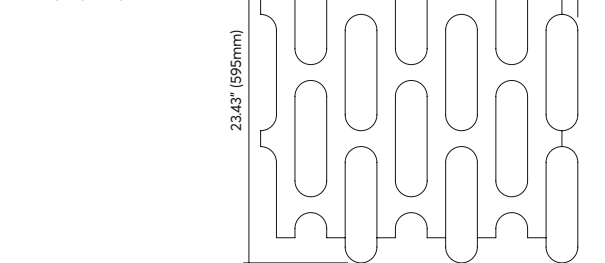

### Pattern Tiles Specifications

Dimensions	See above.
Colors	Available in all 64 Colors, including Zintra Timber and Premium Prints. See <b>p.11</b> , <b>p.12</b> and <b>p.13</b>
NRC Rating	Directly Mounted: 0.45 - 0.75
Aw Rating	Directly Mounted: 0.30 - 0.60
Suggested Installation	Supplied as a set of individual tiles. Arrange as required and fix to the wall with construction adhesive. As an alternative solution, use a Non-Destructive Removable Fixing (NDRF) (sold separately). See <b>p.200</b> for hardware detail. Check out the Technical Documents on our website to download the Installation Guide for more details.
Additional Comments	Also available with Digital Print. Not suitable as a free standing product.
Customization	The Zintra Acoustic Solutions range is customizable to your project. Please get in touch with your local contact for details.



# Hardware

Discover versatile hanging systems and sturdy fixing options, designed to complement and secure the Zintra product range whilst being considerate of installation needs.

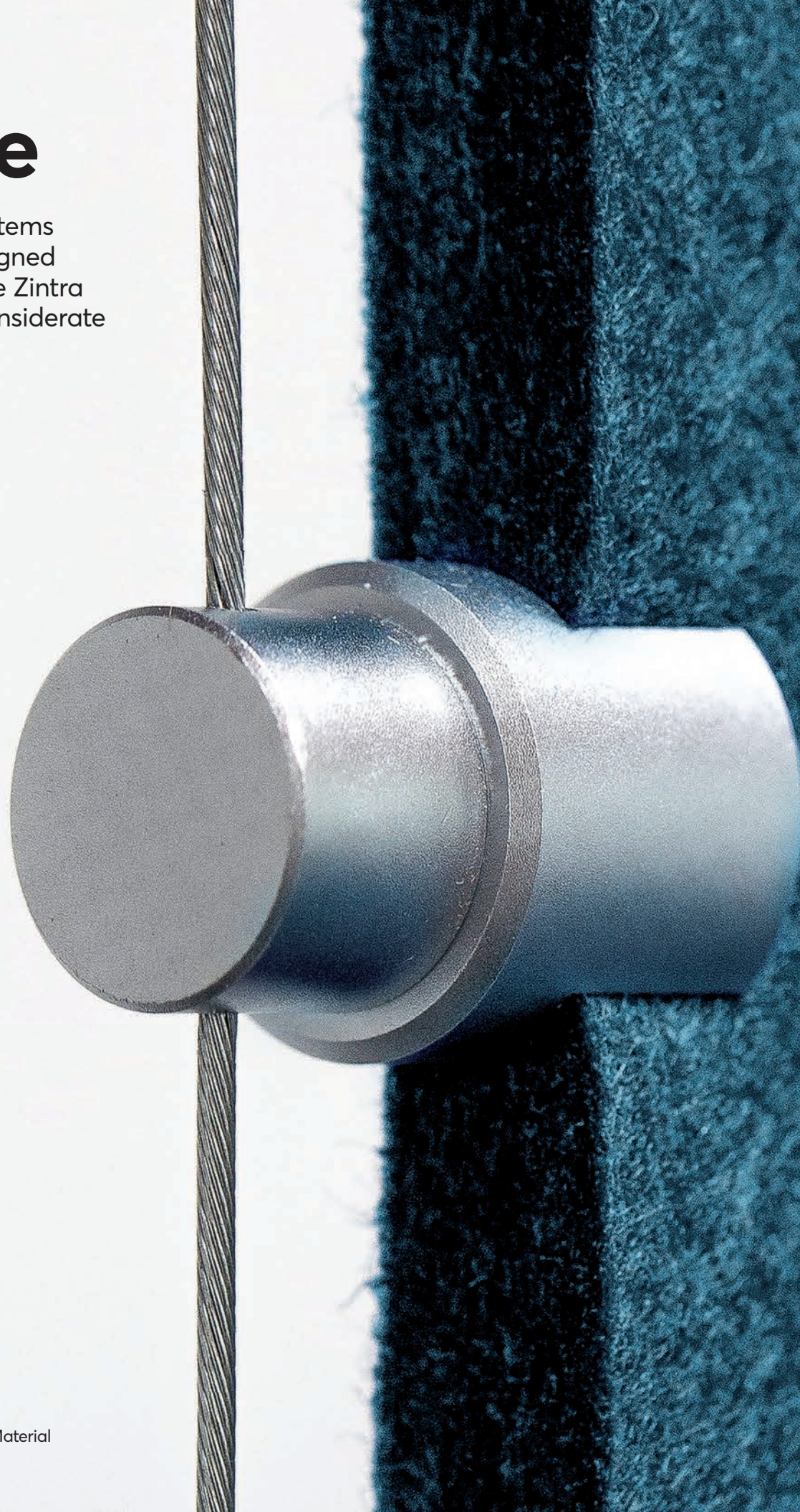

# Floor to Ceiling Screens

Zintra Floor to Ceiling Screens utilize a steel cable to suspend Zintra Panels or Patterns. They are an easy-to-install and cost-effective room dividing solution.



206. Product: Zintra Patterns Astra | Color: Sunshine

## Cable Side Grippers

Front view

Size varies, as it depends on the panel being suspended

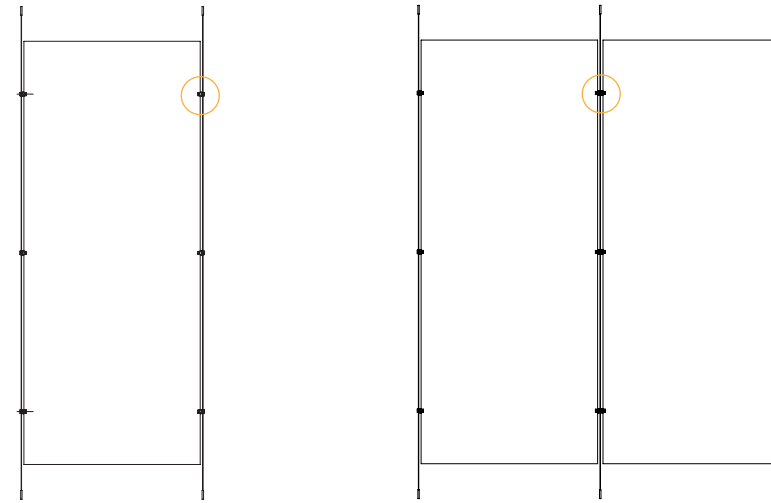

Single Sided Gripper

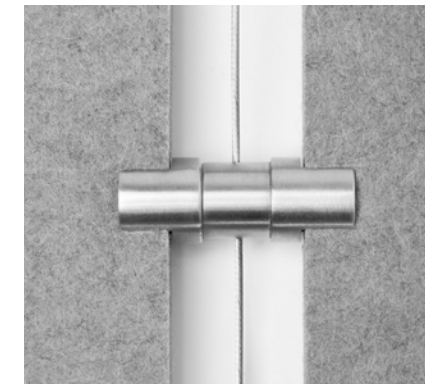

Double Sided Gripper

## Cable Standoff

Front view

Size varies, as it depends on the panel being suspended

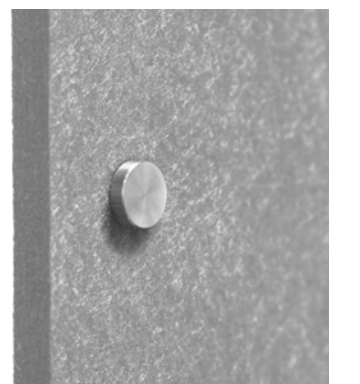
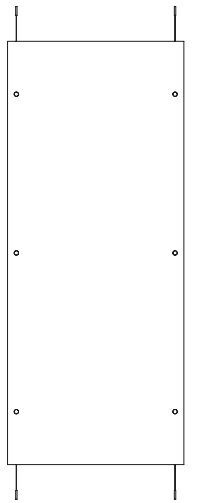

## Floor to Ceiling Specifications

Colors	Available in all 64 Colors, including Zintra Timber and Premium Prints. See p.11, p.12 and p.13	
NRC Rating	With 6" (152mm) Air Gap: Up to 0.90	With 12" (305mm) Air Gap: 0.95
Aw Rating	With 6" (152mm) Air Gap: Up to 0.95	With 12" (305mm) Air Gap: 0.95
Suggested Installation	Fix cables into floor and ceiling with suitable anchors (requires rigid ceiling and floor), tension cable and hang screen using supplied side gripper or standoff.	
Additional Comments	Zintra Patterns and Floor to Ceiling System sold separately.	
Customization	The Zintra Acoustic Solutions range is customizable to your project. Please get in touch with your local contact for details.	

# Sliding Screens

Zintra Sliding Screens combines Zintra Patterns with easy to install hardware, allowing flexible room division with outstanding acoustic quality.



208. Product: Zintra Sliding Screens Bhushan | Color: Sky

## Sliding Track Assembly

Zintra Patterns not included

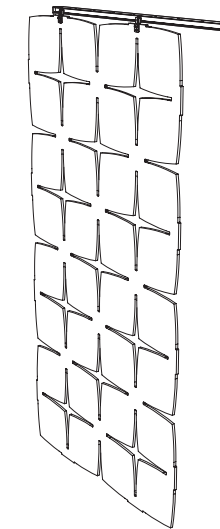
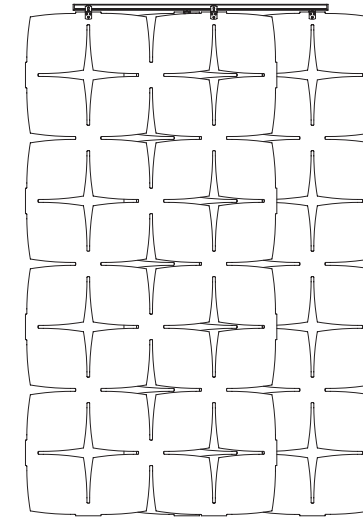

One screen

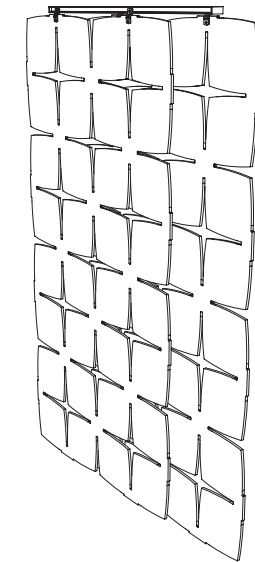

Two screens

## Sliding Screens Specifications

Dimensions	Screens are dependent on order. Sliding Track comes in 108" lengths	
Colors	Available in all 64 Colors, including Zintra Timber and Premium Prints. See p.11, p.12 and p.13	
NRC Rating	With 6" (152mm) Air Gap: Up to 0.90	With 12" (305mm) Air Gap: 0.95
Aw Rating	With 6" (152mm) Air Gap: Up to 0.95	With 12" (305mm) Air Gap: 0.95
Suggested Installation	Fix track to ceiling with suitable anchors (requires rigid ceiling), hang panel on track, insert decorative end caps.	
Additional Comments	Zintra Patterns, Rollers and Double Sliding Track are sold separately. Available as one single screen or overlapping multiple screens.	
Customization	The Zintra Acoustic Solutions range is customizable to your project. Get in touch with your local contact for details.	



### Adjustable Suspension Kit (ASK)

Dimensions: Steel Cable North America / Asia – 5' (1524mm)  
Europe – 6 1/2' (2000mm)

Finish: Silver  
Notes: Kit includes Steel Cable, Barrel Fixing, Anchor Bolt & Adjustable Toggle

Used With: Baffles – Individual & Systems, Clouds, Connect & Shapes  
Comments: 5' length is standard. Ad'tl lengths available upon request



### 4 Way Adjustable Cable Kit

Dimensions: Steel Cable 5' (1524mm)

Finish: Brushed stainless steel  
Notes: Kit includes Steel Cable, 2x leg cables with toggle end, Barrel Fixing, Anchor Bolt & Adjustable 4-way splitter

Used With: Baffles Connect Cubix, Hive, Prismatic & Turbine Cloud  
Comments: 5' length is standard. Ad'tl lengths available upon request



### Y- Hook Cable Hanger

Dimensions: Gripper Angel Y-Hook 11.8" (300mm) with Top Hat End Fixing, 5' (1524mm) Cable Hanger.

Finish: Brushed Silver  
Notes: Refer to installation guide on our website for where and how to install.

Used With: Mesh Baffles  
Comments: 5' length is standard. Ad'tl lengths available upon request



\*rope not included

### Wire Clamp

Dimensions: Suitable for 3/16" diameter

Finish: Zinc-Plated Steel  
Notes: Easy-Install Wire Clamp (Not for Lifting). Used when installing multiple mesh baffle systems together.

Used With: Mesh Baffles



### Square Tube 1" (25mm) X 1" (25mm)

Dimensions: 1" (25mm) x 1" (25mm) x 108" (2743mm)

Finish: Satin Aluminium or Black

Used With: Baffles, Sticks

\*Can come Notched or Unnotched dependent on product



### U-Channel

Dimensions: North America/Asia – 0.5" (12mm) x 0.5" (12mm) x 108" (2743mm)

Finish: Black or White

Notes: Compatible with 1/2" (12mm) thick Zintra Acoustic Solutions

Used With: Individual Baffles



### Twist Clip Threaded

Finish: Silver

Notes: North America/Asia – Compatible with 15"/16" ceiling grid  
Europe – Compatible with T24 ceiling grid  
Requires Adjustable Suspension Kit (ASK) (sold separately)

Used With: Baffle Systems, Baffles Individual, Clouds & Shapes



### Twist Clip Swivel

Finish: Clear

Notes: Not available in Europe  
Compatible with 15"/16" ceiling grids  
Requires S-Hook (sold separately)

Used With: Individual Baffle



### Twist Clip Loop

Finish: White

Notes: North America/Asia – Compatible with 15"/16" ceiling grid  
Europe – Compatible with T24 ceiling grid  
Requires S-Hook (sold separately)

Used With: Individual Baffles



### S-Hook

Finish: Silver

Notes: Requires Twist Clip – Loop or Twist Clip – Swivel

Used With: Individual Baffle



### Cup Hook

Dimensions: Overall Dimensions 1.26" (32mm) x 0.65" (17mm)

Finish: White or Black

Used With: Individual Baffles – Hook & Small Shapes



### Grommet

Dimensions: 3/4" (19mm) diameter

Finish: Silver or Brass

Notes: Suitable for 1/2" (12mm) only

Used With: Baffle Systems Individual Grommet



### Strut Mount

Dimensions: 1.5" w x 1.875" l

Finish: Silver

Notes: Includes: (1) Strut Mount & (1) Push-In Rivet

Compatible with 1-5/8" wide strut channels. Suitable strut heights ranging from 13/16", 1-3/8", 1-5/8", 2-7/8" or 3-1/4". Requires Beam Clips (sold with product or purchased ad'tl). Strut channel not included.

Used With: Beams



### Beams Clip 1/2" (12mm)

Dimensions: 1/2" (12mm)  
Finish: Clear – injection moulded plastic.  
Notes: Clear hardware for securing 1/2" Zintra to a wall or ceiling.  
Used With: Beams & Box Tiles



### Beams Clip 1" (24mm)

Dimensions: 1" (24mm)  
Finish: Clear – injection moulded plastic.  
Notes: Clear hardware for securing 1/2" Zintra to a wall or ceiling.  
Used With: Beams & Box Tiles



### Standoff – 1" (25mm)

Finish: Brushed Stainless Steel  
Notes: Compatible with Zintra Acoustic Solutions up to 1" (24mm) thick  
Used With: Panels, Patterns, Etch & Emboss



### Standoff – 1.75" (45mm)

Finish: Brushed Stainless Steel  
Notes: Compatible with Zintra Acoustic Solutions up to 1" (24mm) thick  
Used With: Panels, Patterns, Etch & Emboss



### Standoff – 2.5" (65mm)

Finish: Brushed Stainless Steel  
Notes: Compatible with Zintra Acoustic Solutions up to 1" (24mm) thick  
Used With: Panels, Patterns, Etch & Emboss



### Z-Clips

Dimensions: 1.5" (38mm) or 72" (1829mm)  
Finish: Aluminium mill finish  
Notes: Sold as pairs  
Used With: Panels, Etch & Patterns with Backer



### Non Destructive Removable Fixing - NDRF

Dimensions: 2" (51mm) w x 1" (25mm) h x 0.2" (4mm) d  
Notes: Sold as a kit – 12 pairs  
Used With: Panels, Patterns, Etch, Textures & Plain Tiles



### Double Sliding Track

Dimensions: North America/Asia – 1.4" (35 mm) x 2.2" (56mm) x 96" (2438mm)  
Finish: Satin Aluminium  
Used With: Sliding Track



### Roller Kit

Finish: Stainless Silver  
Notes: Minimum of (2) Roller Kit required for 1/2" (12mm) panels 48" (1220mm) wide or less  
(3) Roller Kit required for panels wider than 48" (1220mm)  
Requires Double Sliding Track (sold separately)  
Kit includes roller and fixing plate  
Not suitable for 1" (24mm) products  
Used With: Sliding Track



### Cable Standoff

Finish: Brushed Stainless Steel  
Notes: Requires Floor to Ceiling Cable Kit (sold separately)  
Compatible with Zintra 1/2" (12mm) Sheets only  
Used With: Floor to Ceiling Cable Kit



### Cable Side Gripper Single

Finish: Brushed Stainless Steel  
Notes: Requires Floor to Ceiling Cable Kit (sold separately)  
Compatible with Zintra 1/2" (12mm) Panels only  
Used With: Floor to Ceiling Cable Kit



### Cable Side Gripper Double

Finish: Brushed Stainless Steel  
Notes: Requires Floor to Ceiling Cable Kit (sold separately)  
Compatible with Zintra 1/2" (12mm) Sheets only  
Used With: Floor to Ceiling Cable Kit



### Floor To Ceiling Cable Kit

Dimensions: 16' (4877mm) Cables  
Finish: Silver  
Notes: Requires Side Gripper Single, Side Gripper Double or Cable Standoff (sold separately)  
Used With: Panel, Patterns & Etch

## TRIMS



### J-Trim

Dimensions: 0.5" (12mm) x 1" (25 mm) x 108" (2743mm)  
Finish: Satin Aluminium  
Notes: Compatible with Zintra 1/2" (12mm) Sheets only  
Used With: Panels, Patterns, Etch & Textures



### L-Angle 1" (25mm) X 1" (25mm)

Dimensions: 1" (25mm) x 1" (25mm) x 108" (2743mm)  
Finish: Satin Aluminium  
Used With: Panels, Patterns, Etch & Textures



### L-Angle 1/2" (12mm) X 1" (25mm)

Dimensions: 1" (25mm) x 0.5" (12mm) x 108" (2743mm)  
Finish: Satin Aluminium  
Used With: Panels, Patterns, Etch & Textures



### Radius Trim

Dimensions: 1" (24mm) x 1" (24mm) x 108" (2743mm)  
Finish: Satin Aluminium  
Notes: Compatible with Zintra 1/2" Sheets only  
Custom finishes available for an additional fee  
Used With: Panels, Patterns, Etch & Textures

## Powder Coat Colors

12 Powder Coat Colors available for selected Baffles and Sticks products.





# MDC

INTERIOR SOLUTIONS

+ 847 437 4000  
info@mdcwall.com  
mdc.is/zintra

COVER: Product: Zintra Mesh Baffles Offset |  
Color: Premium Wood White Oak

Zintra Product Catalog | [mdc.is/zintra](http://mdc.is/zintra)