



zintra[®]
**STICKS TECHNICAL
SPECIFICATIONS**

Zintra Sticks is a range of fabricated acoustic sticks supplied ready to install as a complete system or as individual lengths.

Available in 2745mm lengths, the Zintra Sticks range includes two stick profiles that can be installed to walls or ceilings in your choice of landscape or portrait direction. Purpose designed transition pieces that seamlessly join the systems at inside and outside corners are also available.

Zintra Sticks is a cost effective, light weight and easy to install solution that works with the complete range of Zintra Acoustic Plain and Timber colours and delivers an NRC of 0.90.



Zintra Sticks Bundle + Transition | Narrow | Portrait | Spotted Gum

ZINTRA STICKS INSTALLATION IDEAS



Zintra Sticks Bundle | Narrow | Portrait | Spotted Gum



Zintra Sticks Bundle + Transition | Wide | Portrait (left) + Landscape (right) | Malachite



Zintra Sticks Bundle + Transition | Narrow | Landscape | Merbau

zintra®

ZINTRA STICKS TECHNICAL DETAIL

Zintra Sticks is available either as a complete system (aluminium frame + sticks) or as individual sticks. The sticks are available in two widths and the complete range of Zintra Sticks species and Zintra standard colours.

Complete Installation Guide also available.

Sticks Suspension Kit is used to install Bundles below services, at different heights or where direct fixing to a ceiling is not an option. With the wire hangers included, heights can be easily adjusted to ceiling type and angles.

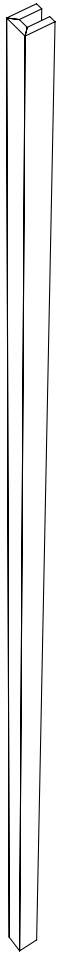

NARROW STICK

2745mm h x 42mm w x
48mm d

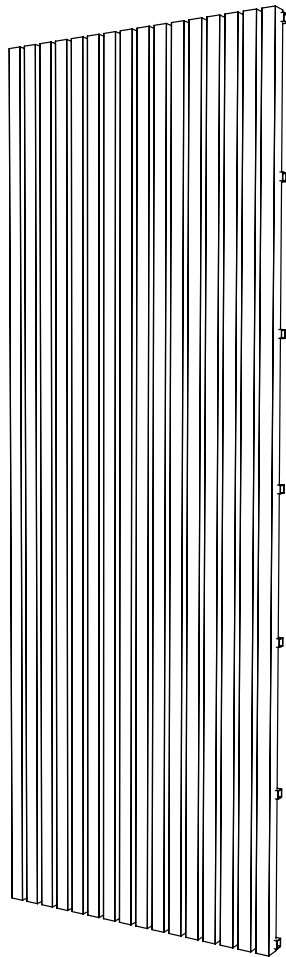

STICKS BUNDLE NARROW

2745mm h x 953mm w



WIDE STICK

2745mm h x 102mm w x
48mm d

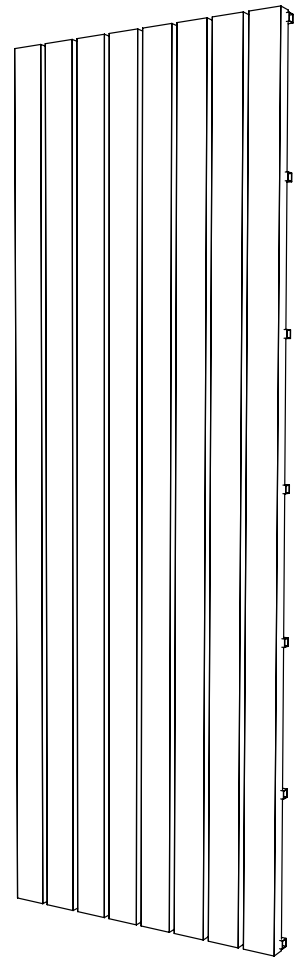

STICKS BUNDLE WIDE

2745mm h x 953mm w

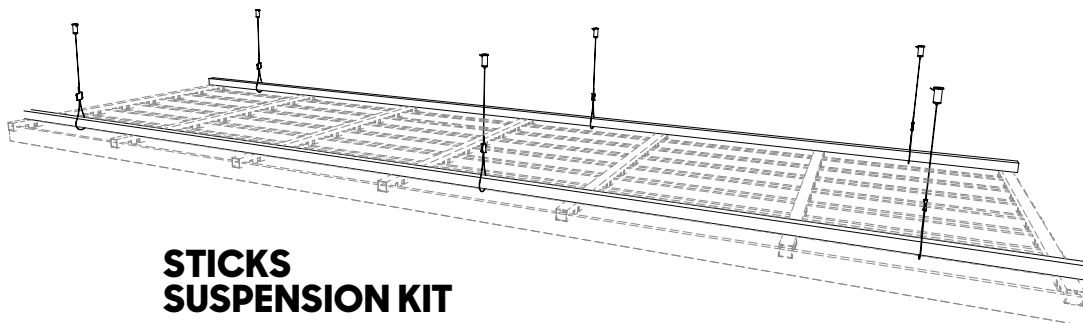

STICKS SUSPENSION KIT

To suit Bundle up to 2745mm w x
953mm l. 25mm d.

ZINTRA STICKS TECHNICAL DETAIL IN PORTRAIT

TYPICAL PORTRAIT TRANSITION ASSEMBLY

101mm wide stick profile

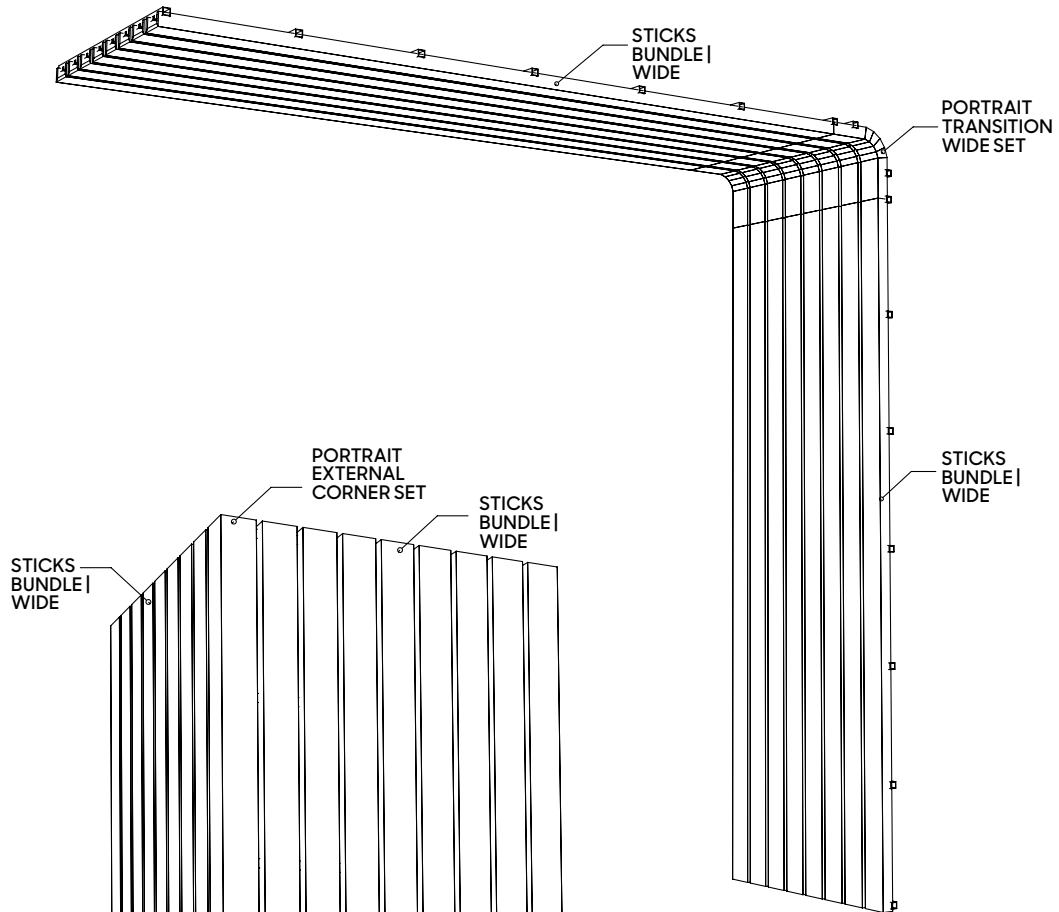

TYPICAL PORTRAIT EXTERNAL CORNER ASSEMBLY

101mm wide stick profile

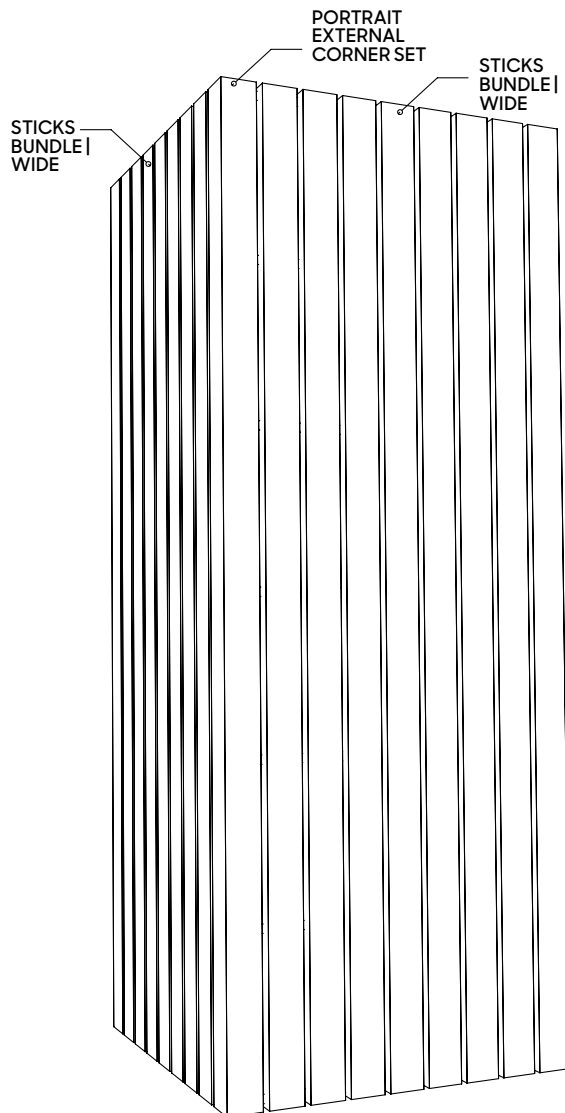

ZINTRA STICKS TECHNICAL DETAIL IN PORTRAIT

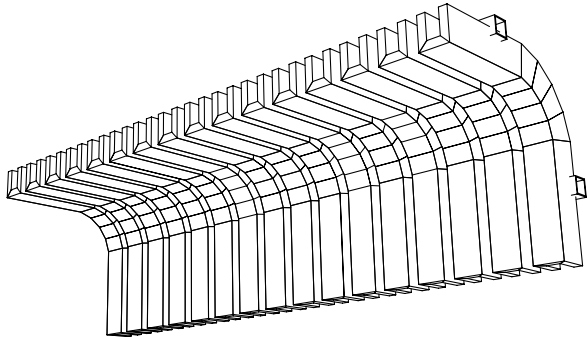

PORTRAIT TRANSITION NARROW SET

289mm h x 953mm w

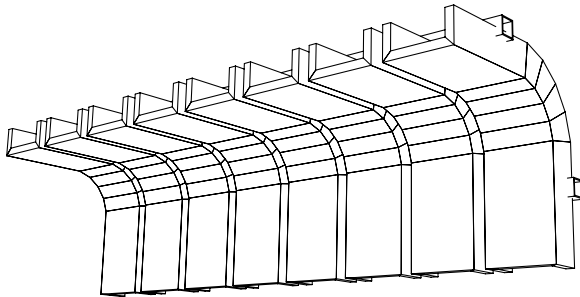

PORTRAIT TRANSITION WIDE SET

289mm h x 953mm w

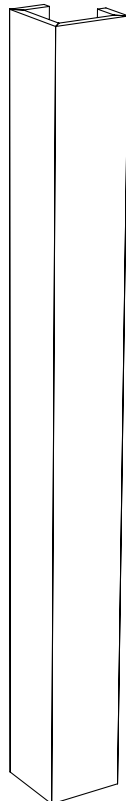

PORTRAIT EXTERNAL CORNER SET

2745mm h x 101mm w

ZINTRA STICKS TECHNICAL DETAIL IN LANDSCAPE

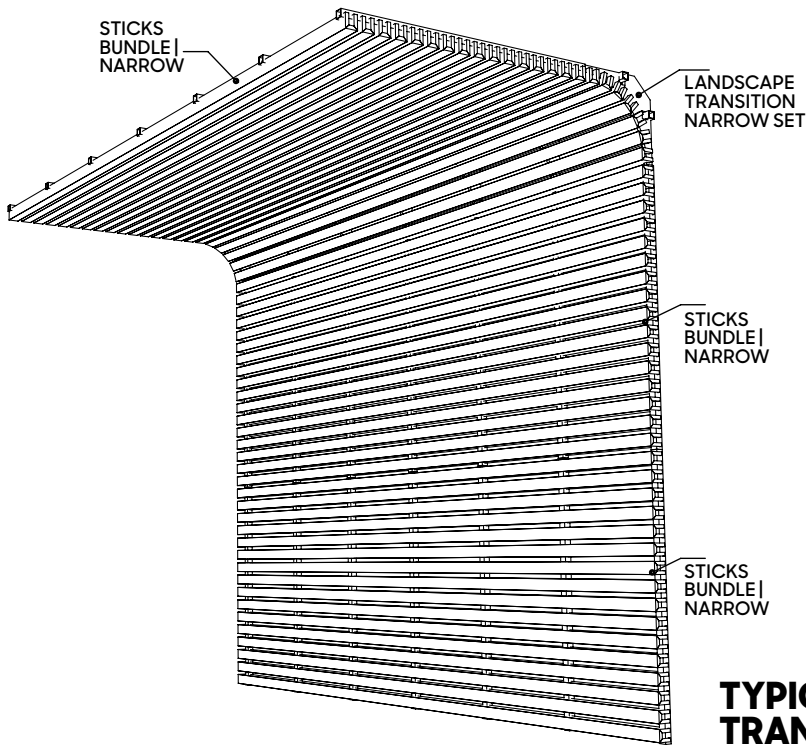

TYPICAL LANDSCAPE TRANSITION ASSEMBLY

42mm wide stick profile

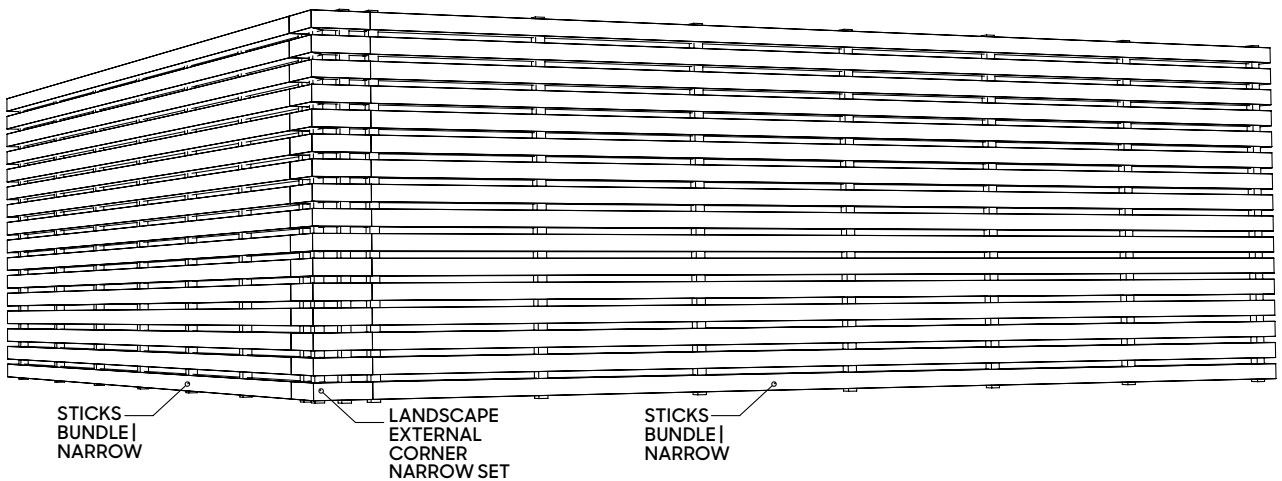

TYPICAL LANDSCAPE EXTERNAL CORNER ASSEMBLY

42mm wide stick profile

ZINTRA STICKS TECHNICAL DETAIL IN LANDSCAPE

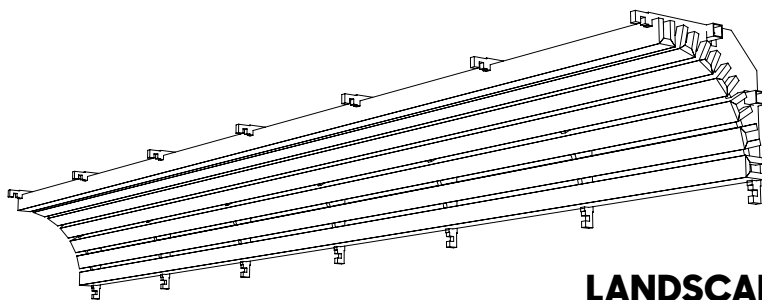

**LANDSCAPE TRANSITION
NARROW SET**

296mm h x 2745mm w

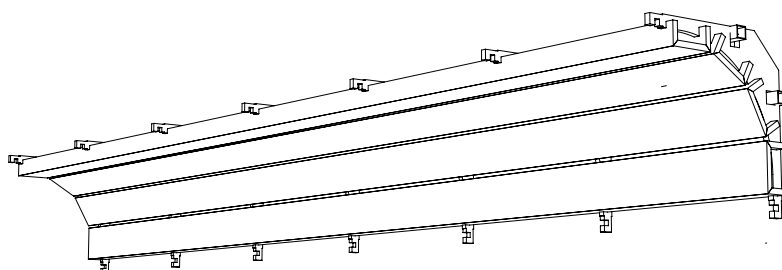

**LANDSCAPE TRANSITION
WIDE SET**

326mm h x 2745mm w

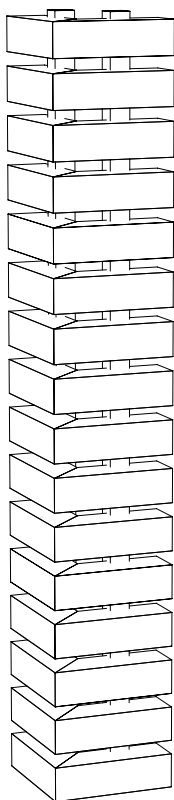

**LANDSCAPE EXTERNAL
CORNER NARROW SET**

953mm h x 152mm w

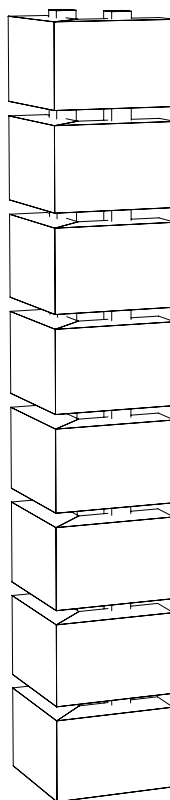

**LANDSCAPE EXTERNAL
CORNER WIDE SET**

953mm h x 152mm w

ZINTRA STICKS TRIM

Zintra Sticks is impeccably finished around windows, doors, ceiling services and GPOs with our simple but polished Sticks Trim. Supplied as a separate right angle piece, Sticks Trim is easily cut in the field to mitre or butt join and glue to Sticks sets to provide a matching Timber finish to exposed ends.

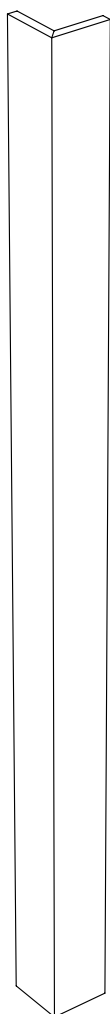

STICKS TRIM

2745mm h x 73mm w x 73mm d



Zintra Sticks Bundle + Trim | Wide | Ironbark



Zintra Sticks Bundle + Trim | Spotted Gum



Zintra Sticks Bundle + Trim | Wide | Ironbark

ZINTRA DETAILS:

CONTENT

100% Polyester.

ACOUSTIC RATING

In accordance with ASTM C423-09a, Zintra Sticks – 12mm achieve between 0.45–0.90 NRC depending on testing layout. Due to the layout of Zintra Sticks, a 0.9 NRC will be achieved.

| Frequency/Hz | | 100 | 125 | 160 | 200 | 250 | 315 | 400 | 500 | 630 | 800 | 1000 | 1250 | 1600 | 2000 | 2500 | 3150 | 4000 | $\bar{\alpha}$ | NRC |
|--------------------|-------|------|------|------|------|------|------|------|------|------|------|------|------|------|------|------|------|------|----------------|------|
| DISTANCE FROM WALL | 0mm | 0.03 | 0.01 | 0.09 | 0.04 | 0.05 | 0.09 | 0.12 | 0.25 | 0.32 | 0.49 | 0.61 | 0.72 | 0.82 | 0.85 | 0.91 | 0.94 | 0.95 | 0.44 | 0.45 |
| | 50mm | 0.20 | 0.16 | 0.22 | 0.32 | 0.46 | 0.56 | 0.63 | 0.80 | 0.89 | 1.03 | 1.04 | 0.99 | 1.07 | 1.00 | 0.93 | 0.87 | 0.92 | 0.81 | 0.80 |
| | 150mm | 0.29 | 0.46 | 0.44 | 0.57 | 0.69 | 0.81 | 0.97 | 0.96 | 0.91 | 1.04 | 0.92 | 0.80 | 0.94 | 0.94 | 0.91 | 0.90 | 0.91 | 0.87 | 0.90 |

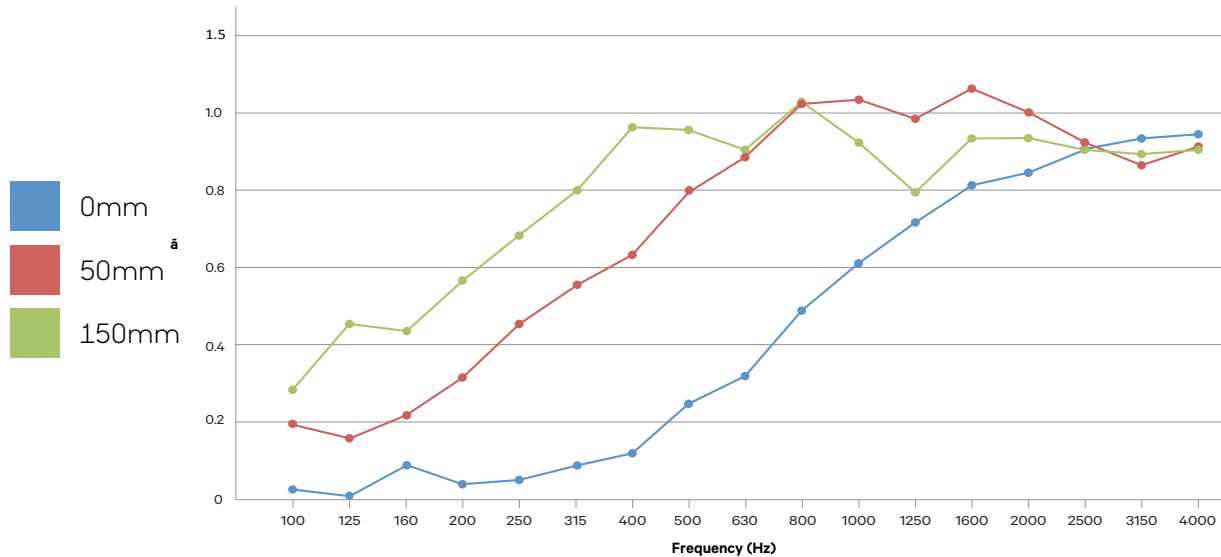

APPLICATION

Indoor areas only.

FIRE RATING

In accordance with:

ASTM-E84 – Class A classification

AS ISO 9705 – 2003 – Group 1 classification

EN-13501 – B-s2-d0 classification

LIGHTFASTNESS

In accordance with AATCC 16.3, Option 3, Zintra Sticks – 12mm panels colour change at 40AFU is 4.5

TEMPERATURE CAPABILITIES

The maximum temperature Zintra Sticks 12mm should be exposed to is 115°C.

MOISTURE ABSORPTION

Polyester fibre when exposed to an atmosphere of 49°C at 90% relative humidity for four days showed moisture absorption of less than 0.03% by weight.

VOC TESTING

In accordance with Standard Method Version 1.2 for CDPH 01350, Zintra Sticks received a PASS for all testing scenarios.

ENVIRONMENTAL

Zintra Sticks – 12mm panels are manufactured using 100% virgin polyester.

Virgin polyester is used to create a consistent panel, with bright colour and a smooth surface.

Zintra is fully recyclable at end of life.

CARE INSTRUCTIONS

Vacuum to remove dust. Remove spills immediately using a clean damp cloth or with soap and water. Polyester carpet and fabric cleaners can be used (always test an inconspicuous area first). A stain repellent coating is available for additional protection. Disinfection – Bleach can be used in accordance with CDC Cleaning and Disinfection instructions. The solution ratio should be 5 tablespoons of bleach to 3.7 ltr of water or 4 teaspoons of bleach 0.95 ltr of water. Spray apply the solution as a mist and then wipe off the surface moisture.

zintra®

ZINTRAACOUSTIC.COM | +1 855 922 7377 | HELLO@ZINTRAACOUSTIC.COM